



Screw Cam Clamp

SCC
SCC-W

Operation Manual

This operation manual explains the basic operation and handling of the clamps. Please read this manual carefully before use and observe the precautions for safe operation.

SUPER TOOL CO., LTD.



brand lifting clamps are energy-saving lifting equipment which have been developed for the purpose of transporting steel materials.

Proper use

Operate lifting clamps after carefully reading and understanding this instruction manual for enhancing efficiency and safety of operation.

Prime efficiency and economy

Advanced functions, reasonableness and versatile applications of finely and carefully designed  lifting clamps ensure prime efficiency and economy.

Special considerations on safety

We conduct a pulling test with a load three times (or twice) of rated capacity and a manufacturing serial number is marked on each product, thus directing a special attention to safety.

Precautions for safety operation

(Pages 1~10 are common to all lifting clamp models)

Be sure to read this instruction manual carefully before use.

Mistaken use of lifting clamp may cause a danger such as dropping of load.

Education of “crane safety regulations,” “operation manual for lifting clamp,” “your company’s operation standards,” etc. should be given before actual operation not only to business owners who have purchased clamps but also to their operators to ensure that actual operators have acquired enough knowledge, safety information, and precautions of the clamps.

Safety precautions are divided into two classifications in this manual; “Warning” and “Caution,”.



WARNING:

Indicates a potentially hazardous situation which, if not avoided, could result in death or serious injury.





CAUTION:

Indicates a potentially hazardous situation which, if not avoided, could result in medium damage or slight injury, or could result in property damage.

While only mentioned in  CAUTION, failure to comply with them still may lead to a serious disaster. As such, do not fail to pay attention both to WARNING and CAUTION which are of great importance.

Meanings of Signs

The signs of  and  indicate that precautions should be taken. The contents of warning or caution are described at each sign.



The sign of  indicates prohibited actions.

The sign of  indicates that an action is enforced or instructed.







Two point lift for  righthand figure.

※ After reading this manual, make sure to keep it at a place of easy access by any users.







1. Handling in general

 WARNING	
<ul style="list-style-type: none"> ● Do not operate until the contents of the operation manual, and caution tag/plate are thoroughly read and understood. ● Do not operate without a legal qualification. ● Be sure to clear of the area of the operation for lifting or turning a load against possible drop off or fall over. ● Do not use for other than intended purpose. 	 Prohibited
<ul style="list-style-type: none"> ● Make sure to execute an inspection periodically and before each operation. 	 Instructed



2. Check before operation





 WARNING	
<ul style="list-style-type: none"> ● Do not use clamp unsuitable for the operation method. ● Do not use clamp of an abnormal condition; deformed, cracked, worn, malfunctioning, etc. ● If the load is under the following conditions, do not use clamp. (A material of fragile, high-hardness, low-hardness or extremely low-hardness, or a member with the gripping part tapered down more than 8°) 	 Prohibited
<ul style="list-style-type: none"> ● Check the type, rated capacity, clamp range, and “periodic inspection completed” label displayed on clamp body. ● The load to be lifted shall be within an allowable range of rated capacity of clamp. ● Thickness of load shall be within designated clamping range. 	 Instructed
 CAUTION	
<ul style="list-style-type: none"> ● Do not use clamp for the load under the following conditions. (Load to be lifted is more than 150°C, or in an atmosphere or solution of acid or alkaline chemicals less than minus 20°C) 	 Prohibited
<ul style="list-style-type: none"> ● Sling to be used for the clamp shall be an appropriate one for lifting operation. 	 Instructed

3. Lifting operation





 WARNING	
<ul style="list-style-type: none"> ● Do not use clamp, lifting at one point. (excluding special or custom ordered products) ● Do not use the clamp in the following ways of lifting: lifting of two or more individual objects at one time. (overlapped loads, padded load etc. , or side gripping) ● Do not use the clamp for pulling out steel plate sheet from the steel sheet pile or for vertical lifting of the sheet. ● Do not use the clamp when strong wind may threaten to cause any danger. ● Do not use the clamp for a hydraulic shovel. 	 Prohibited
<ul style="list-style-type: none"> ● Install two or more clamps in a balanced way to keep the balance of load. 	 Two point lift
<ul style="list-style-type: none"> ● The lifting angle of the clamps and the dividing angle should be kept within the allowable angles according to types. ● Load should be inserted to the innermost end of the jaw opening. ● When you use the clamp with a lock mechanism, never fail to have the lock engaged. 	 Instructed
 CAUTION	
<ul style="list-style-type: none"> ● If oil, paint, scale, rust, etc. are on the gripping pad, do not use the clamp. ● Do not drop clamp or drag on the ground. 	 Prohibited

4. Operation of a crane

 WARNING	
<ul style="list-style-type: none"> ● Never lift a load exceeding the rated capacity. ● Do not operate a crane in such a way as to give an impact to the load or the clamp. ● Do not allow a person to stand on the load or to carry him. ● Do not lift a load which is not free from any other objects. ● Do not release the lock of clamp while lifting load. ● Avoid unintended contact by load to an adjacent member or to the clamp, which has been removed from the load. 	 Prohibited

<ul style="list-style-type: none"> ● Stop the lifting operation by crane for a moment when the load is applied to the lifting ring for safety checking. (depth of the load into the clamp opening; status of locking). ● Stop the operation of the crane just before the load reaches the ground, and check the following matters: (Inclination or falling over of the load and security around the landing area of the load) 	 Instructed
 CAUTION	
<ul style="list-style-type: none"> ● Do not operate the crane in such a way as to drag the load along the ground. ● Do not leave the crane (or winder, etc.) unattended from an operating position while keeping the load lifted with the clamp. 	 Prohibited
<ul style="list-style-type: none"> ● Raising and lowering operation by crane should be done slowly and carefully. 	 Instructed

5. Maintenance, storage and alteration

 WARNING	
<ul style="list-style-type: none"> ● Never alter the clamp and its accessories. ● Do not apply welding or heat to the clamp or its accessories. ● Do not use any other parts than our company's genuine parts. ● Clamps which require the repair should be stored at a different place so that they are not used mistakenly. 	 Prohibited
<ul style="list-style-type: none"> ● Persons with specialized knowledge designated by the business owner are to conduct maintenance and repairing work. ● When any abnormality with the clamp is found, do not use it and immediately repair or dispose. ● Remove, if any, paint or mud sticking to the moving parts of the clamp, cams, and pads. 	 Instructed
 CAUTION	
<ul style="list-style-type: none"> ● Conduct maintenance and repairing without any load attached. ● Conduct maintenance and repairing after posting a sign indicating that you're on the maintenance work. ● Never fail to lubricate oil on the rotating parts of the clamp (around the pins), guide grooves, sliding parts, etc. ● Be sure to store clamps indoor. 	 Instructed

■ General warning for use (common to all lifting clamp models)

1. Be sure to select proper model clamps for use.

Pay special attentions to keep the lifting direction (rope angle).

2. Confirm the weight of the load. Do not exceed maximum capacity (designated ton) on clamps. (Never overload.)
3. Before use, confirm followings:
 - (a) Proper capacity of clamps.
 - (b) No abnormal movements of clamp or loosening of any bolts.
 - (c) No oil or other foreign matters on the surface of the cam and pad.
4. **Never use for load beyond the clamp range.**
5. When installing clamps, insert a lifting load completely until it comes in contact with the deepest of the jaw opening of main body.
6. **Depending on the model or capacity of the clamp, the cam teeth may not bite a load sufficiently when the load is a hard or light weight material (Less than 1/5 of maximum capacity or less than 1/4 of maximum clamp range). Confirm the condition of clamp for safety.**
7. Confirm that the safety lock is completely engaged in case clamp has a built-in lock.
8. Confirm that the load is well balanced. Determine the clamp position or the center of gravity of the rope properly. It is especially important to determine the horizontal center of gravity.
9. When lifting at 2 points, be sure to use two wire ropes, and make them equal length. (Fig. A)

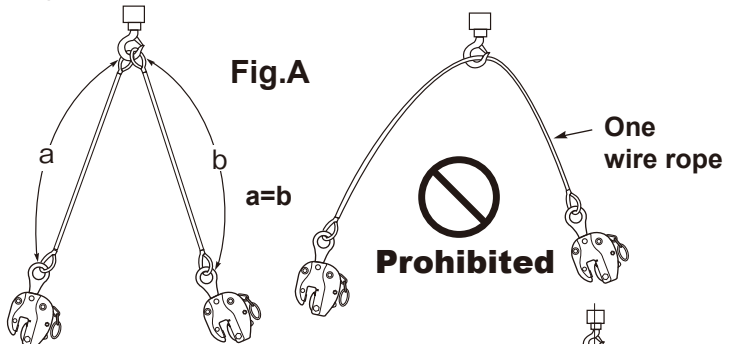

10. When lifting at 2 points, keep the lifting angle within 60°. (Fig. B)

(Follow the standards if lifting angle is specified depending on items.) If the load is long, use a balance.

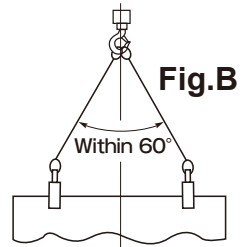

11. Never lift two or more steel plates or steel members at a time.
12. The load may move to an unexpected direction when lifted off the ground and as such confirm the center of gravity and the clamping position for safety when raising. Sufficient caution should be taken until the clamp with the load becomes completely balanced.
13. When changing directions of the load or any similar operations, all personnel must be clear of the area of operation. (Fig. C)

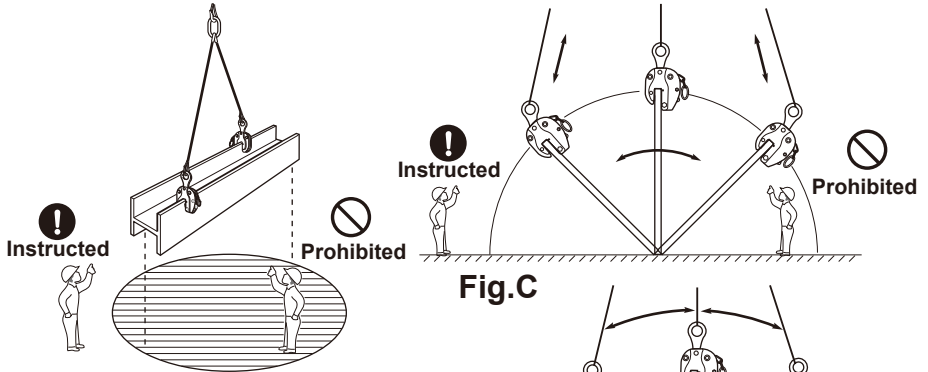

Fig.C

14. Do not ride on the lifting load.
Never use clamp for riding or carrying person.
15. Keep momentary inverting angle of a steel plate within 30°. (Fig. D)

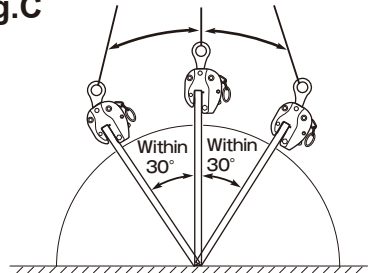

Fig.D

16. **Before operation, the surface of load must always be clean and free of scale, coatings or other foreign matters that will reduce clamping force significantly.**
17. **When raising, special attention must be given to prevent the rope from loosening by its unintended contact with any other objects.**
18. When raising again after the load is put on ground, reconfirm the clamp condition.
19. Do not use clamp for heated load or in a corrosion liquid because safety factor and durability will be reduced in such conditions.
20. Do not alter clamp by welding, cutting by gas or by any other modification.
21. Do not weld electrically a load while being lifted by clamp.
22. Conduct daily maintenance and lubrication.

■ Maintenance and Inspection

1. Maintenance

Daily maintenance is important for efficient and safe operation even under the severe use condition and for such purposes, please comply with the followings.

- (1) Designate the use standards and control.
- (2) Keep clamps indoor and do not leave them outdoor.
- (3) Check the followings to maintain in a good condition.
 - (a) Operating condition.
 - (b) Any abrasion, damage, or clogging at teeth of cam and pad.
 - (c) Deformation of main body - at jaw opening in particular.
- (4) Separate conforming clamps and other hazardous items identified during use or inspection and designate the defective sections. Perform maintenance any soon.
- (5) For the storage, place soft material as wooden chip in-between cam and pad to protect the teeth.
- (6) Perform inspection and maintenance once a week by referring to "Inspection Standards". Lubricate sliding sections periodically. (However, remove oil at teeth of cam and pad.)

2. Periodic Inspection

Perform periodic inspection in accordance with the periodic inspection and maintenance standards. Functions and life of clamps may differ in a great degree as they are used in varieties of fields under different conditions of use. Therefore, preparation and practice of effective handling/inspection standards manual by users themselves are recommended. We ask you to establish complete maintenance and control for assurance of safety in reference to our Manufacturer's Inspection Standards of our clamp. Clamp is designed for easy replacement of parts and therefore, do not fail to replace defective parts. Also, keeping spare parts at all times is recommended. For your preparation of the standards, pay special attention to the followings.

- (1) Operation and maintenance standards
 - (a) Preparation of use criteria (shape of load and operating methods).
 - (b) Thorough understanding and compliance of cautions on handling.
 - (c) Maintenance and storage.
 - (d) Rules of inspection and check at site.

- (2) Standards on periodic inspection
 - (A) Establishing dates of periodic inspection.
 - (B) Establishing inspection and maintenance methods.
 - (a) Inspecting period.
 - (b) Person in charge of the inspection.
 - (c) Inspection site.
 - (d) Tools and devices for inspection.
 - (e) Establishment of permissible limit of use.
 - (f) Explicit designation of maintenance and repair methods.

3. Manufacturer's inspection method

Our company's inspection procedures are as follow.

Check for

- (1) Movements.
- (2) Wear, loss, and/or clogging of/at the teeth of the cam and screw.
- (3) Deformation of main body.
- (4) Deformation of shackle.
- (5) The status of bolts, pins, links and springs.
- (6) Deep scratches in general.
- (7) Other checking items based on the Standards.

Lifting angle and rated load of wire rope

The maximum rated capacity of wire ropes also differs according to the lifting angle. Therefore, after paying attention to the lifting angle, always use wire ropes with the appropriate diameter.

Correlation table between the lifting angle and the applicable load for wire rope (for 2-point lifting)

■ JIS G 3525 6×24 A type

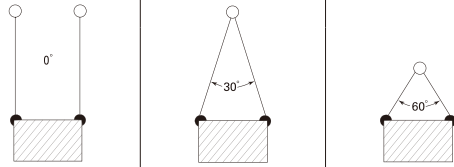
D wire rope diameter (mm)	W rated load (for 1 single rope) [Safety factor S=6] (ton)			
		(Change in % of the lifting capacity rate according to the lifting angle)		
		100%	96%	86%
Maximum allowable load (rated load) for 2 wire ropes (ton)				
6	0.30	0.60	0.57	0.51
8	0.53	1.07	1.03	0.92
9	0.67	1.35	1.30	1.16
10	0.83	1.67	1.61	1.44
12	1.20	2.41	2.32	2.08
14	1.64	3.28	3.15	2.83
16	2.14	4.28	4.12	3.69
18	2.72	5.44	5.23	4.69
20	3.35	6.70	6.44	5.77
22	4.06	8.12	7.81	7.00
24	4.82	9.65	9.28	8.32
26	5.66	11.3	10.8	9.76
28	6.58	13.1	12.6	11.3
30	7.55	15.1	14.5	13.0
32	8.58	17.1	16.5	14.8
36	10.8	21.7	20.8	18.7
40	13.4	26.8	25.8	23.1

Calculation formula of a wire rope diameter and rated load (for 1 single rope)

* Refer to the calculated values as rough indications.

① $D = \sqrt{W \times C}$

② $W = \frac{D^2}{C}$

D= wire rope dia. (mm)
W= rated load (ton)
C= 120 (constant)
(with Safety factor S = 6)

★ When looking for the required wire rope diameter to lift a 3 ton load

① $D = \sqrt{W \times C}$

$D = \sqrt{3 \times 120} = \sqrt{360} = 19 \rightarrow$

20mm

★ When looking for the maximum capacity (rated load) of a wire rope with 12mm diameter

② $W = \frac{D^2}{C}$

$W = \frac{12^2}{120} = \frac{144}{120} = 1.2 \rightarrow$

1.2ton



Screw Cam Clamp

SCC
SCC - W

Operation Manual and Inspection Standards

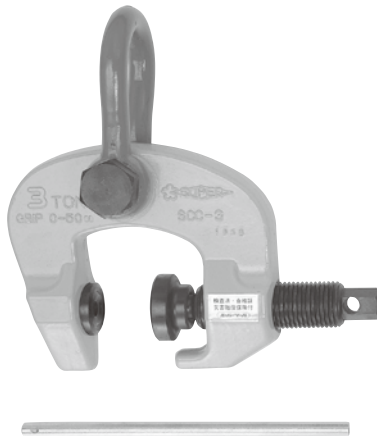

Screw Cam Clamp

SCC SCC-W

■ Uses

Clamps suitable for lifting, suspending, lateral pulling, and turning over steel plates and members in various shapes in such industries as civil engineering, construction, iron and steel, shipbuilding, and steel plate working industries.

■ Features

1. Screw and Cam ensure reliable clamping.
2. In proportion to lifting load, Cam tilts and the contact surface becomes larger and clamps more firmly.
3. The main body is a mold forged product of special alloy steel processed with optimal heat treatment, and thus, strong and durable.

■ Specifications

	Item No.	Rated Capacity (ton)	Clamp Range (mm)	Net Weight (kg)
Standard type	SCC 0.5	0.5	0~28	0.8
	SCC 1	1	0~30	3.2
	SCC 1.5	1.5	0~32	4.0
	SCC 3	3	0~50	6.0
	SCC 6	6	0~75	18.0
Wide Type	SCC 0.3W	0.3	50~100	1.3
	SCC 1W	1	50~100	6.0
	SCC 3W	3	25~75	7.8

REPLACEMENT PARTS AND ASSEMBLIES

Part No.	Part Name	Item No.	Set Q'ty(pc)
Shackle Assembly		SCH	
5	Shackle	SCCH	1
6	Support Bolt (for Shackle)	SCCN	1
12	* Nut (for Shackle)		1
11	Cotter Pin (for Support Bolt)		1
Screw		SCR	
2	Screw	SCCR	1
7	Handle	SCCU	1
3	Cam	SCCT	1 set
10	Stop Ring		
Pad Assembly		SCP	
4	Pad	SCCP	1
8	Bolt (for Pad)	SCCV	1
9	Nylon Nut (for Pad)		1

- When ordering, specify the rated capacity (ton) of item No. (with "W" at the end in case of wide type)
 (Example : Screw for SCC3 is SCCR3)
 (Example : Cam for SCC1W is SCCT1W)
- Handle of SCC0.5 and SCC0.3W is ordered as an assembly, and the Assembly No. is SCR0.5 (0.3W).
- Periodic lubrication is required at a sliding portion of Cam and Screw (spherical portion).

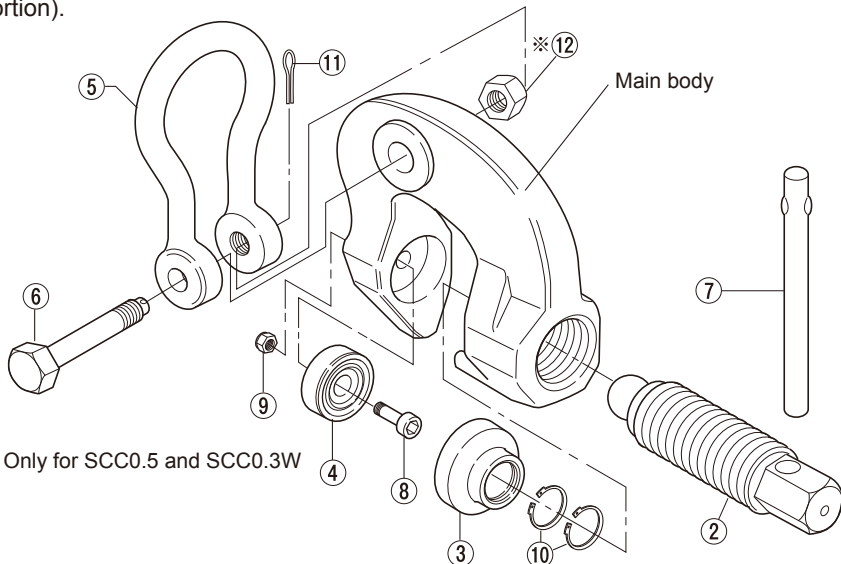

■ How to use

1. OPERATION METHOD

- 1) Screw tightens when turned clockwise, and loosens when turned counterclockwise (Right screw).
- 2) When installing clamps, insert a lifting load completely until it comes in contact with the deepest of the jaw opening of Body and set in a manner that the entire circumferential teeth of inner portion of concentric rings touch the surface of the load.
- 3) Refer below for tightening torque of Screw.
- 4) For SCC0.3W and SCC0.5, during lifting operation and the like, special attention must be given to prevent Screw from loosening by an unintended contact of Handle with wire rope or any other objects. For other sizes, after screw tightening is completed, pull out the handle before lifting.

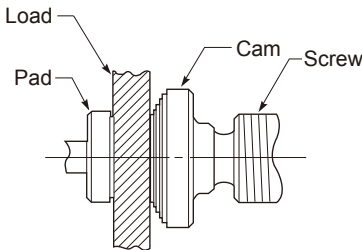
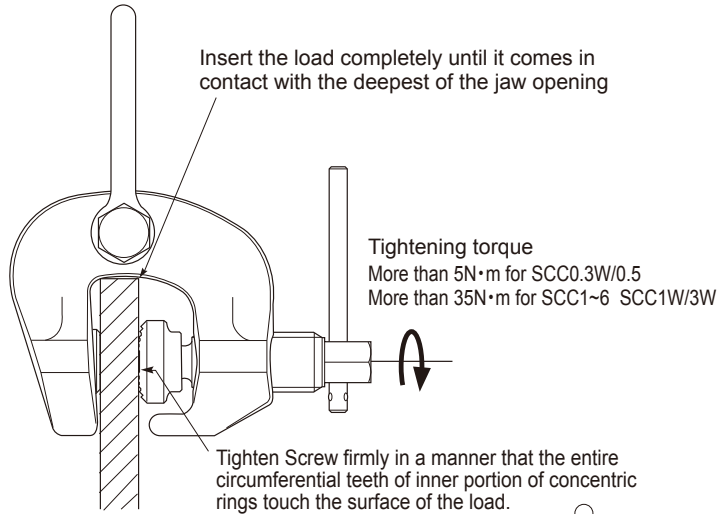

Correct installation

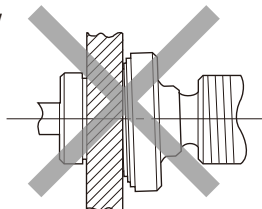

Cams must not be installed in a tilted position.

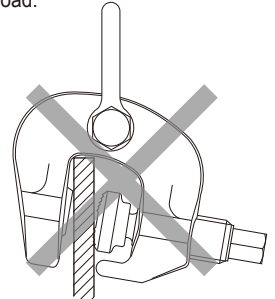

Main body must not be installed in a tilted position.

2. OPERATION PATTERNS

- ① When lifting at 2 points, keep the lifting angle within 60° .

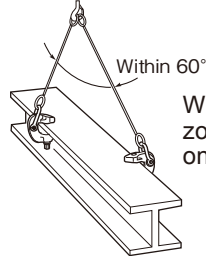
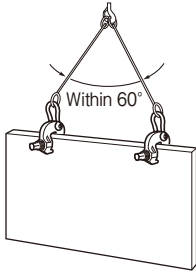

When clamping horizontally, install the pad on the upper side.

- ② Always lift at 3 or more points with complicated shaped objects. (For horizontal lift, always lift at 4 points when lifting a steel plate positioned horizontally to a floor level)

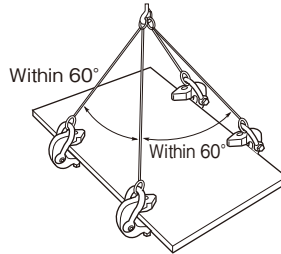
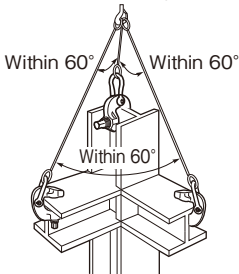

When clamping horizontally, install the pad on the upper side.

- ③ Clamps can also be used for lifting and turning over pipe shaped objects. (Cylinder with inner dia. over 600mm)

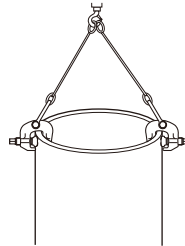
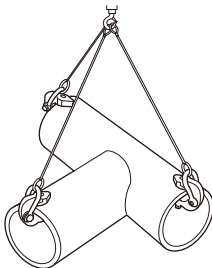

- ④ Clamps can also be used for temporary turning over mold steel or the like.

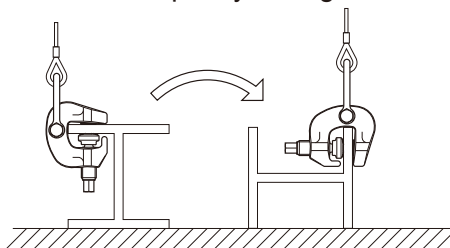

- ⑤ Clamps can also be used for positioning steel structure for welding, pulling and/or suspending.

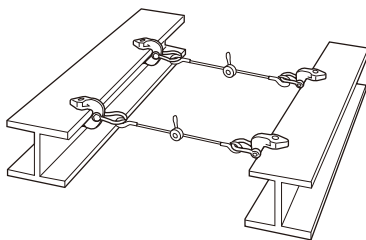

- ⑥ The clamps cannot be used on the following shaped structures.

Round bars



Curve shapes with radius under 300mm

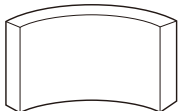

Objects with uneven surface (no flat surfaces) at grips.



Cylinders with inner dia under 600mm

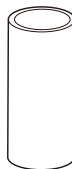

※Wedge shapes over 8°

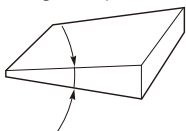

Even in the case the wedge shapes under 8°, lifting up in tapering down direction is prohibited.

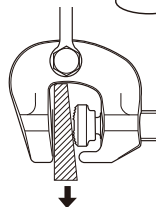

- ⑦ When clamping, make sure that wire ropes and other objects do not get caught between Main body and Shackle.

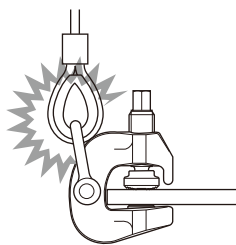

- ⑧ SCC0.5 and SCC-W (wide type) are for vertical lifting only. They cannot be used for horizontal lifting. (SCC0.5 can be used for horizontal lifting by using the long shackle for SCC0.5 (SCH0.5L, sold separately).)

- ⑨ Use as a suspending jig is prohibited.

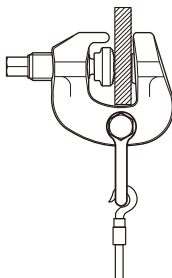

Prohibited

3.DISASSEMBLING AND ASSEMBLING

1.Disassembling

1.Cam and Screw (SCC0.5, SCC0.3W)

Tap the part of Cam shown in Fig. 1 with a hammer or other tool to release Cam from Screw.

(Note: Once released, Cam and Screw cannot be reused. Be sure to replace them with new ones.)

(Other sizes)

Turn Screw counterclockwise till Cam touches the Body, and with further turning, Cam will be taken off. (Fig. 2)

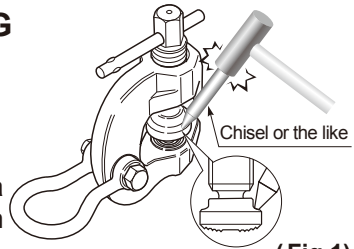

(Fig.1)

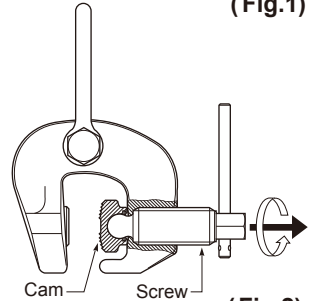

(Fig.2)

2.Pad

Insert hex key into Hex. Hole Head Bolt at the center of Pad and turn with a socket wrench or the like at the opposite side and take off Pad. (Fig. 3)

3.Shackle

Take off Cotter Pin at Bolt for Shackle with long nose pliers or the like, and take off the Bolt for Shackle

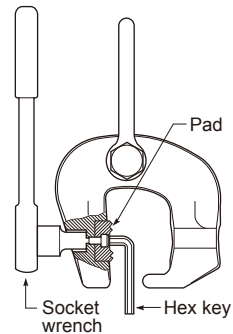

(Fig.3)

2.Assembling

1.Shackle

Insert Bolt for Shackle after aligning holes of Shackle and Body. Put Cotter Pin at the tip of the Bolt for Shackle and bend the tip of Cotter Pin to the left and right with long nose pliers or the like.

2.Pad

Perform the reverse procedure of Disassembling. Tighten Pad sufficiently to avoid its rotation.

3.Cam

Put a Stop Ring (2pcs for SCC0.3W~1.5 and 3pcs for SCC3~6) at female screw of Cam and lubricate the spherical hole. Put a wood piece between Pad and Cam with Stop Ring and tighten Screw so that Cam will be set at the tip of Screw.

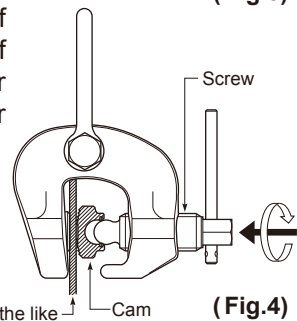

(Fig.4)

■ CAUTION:

- ◆ Use within the rated capacity.
- ◆ Use within the clamp range.
- ◆ Do not use for any objects other than steel materials.
- ◆ Do not use for hard (30 HRC or higher) load.
- ◆ Lifting is not allowed for a load tapering down in upward direction.
- ◆ Do not apply shock to the load or lifting clamp.
- ◆ When using a loaded clamp again without reinstalling it, be sure to retighten torque by the specified torque.
- ◆ Do not lift more than one plate.
- ◆ Before using the product, be sure to check for clogging and wear of the teeth of the cam, screw and any other parts.
- ◆ Do not alter. Heating, modifying, etc. will significantly reduce the quality (strength).

■ OTHER:

- ◆ Inquiries for Repair Parts and Repair.
If repair parts or repairs are required, stop using this clamp and contact your distributor.



■ DAILY INSPECTION:

Conduct daily checks and maintenance to prevent the loss of safety and efficiency.

1. Check that there are no cracks at the body, cam, or wire rope holes.
2. Check if the movement and lubrication condition of each part are good.
3. **Check for wear, loss, or clogging of the teeth of the cam and screw.**
4. Refer to other inspection standards.

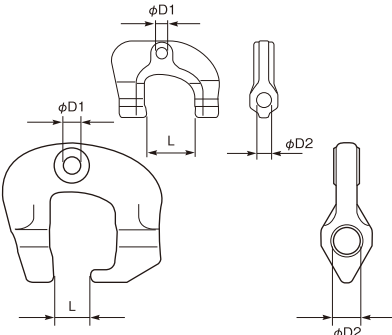
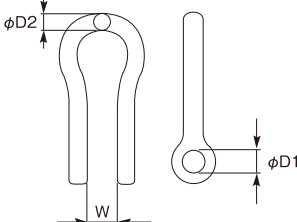
INSPECTION STANDARDS FOR SCC / SCC-W

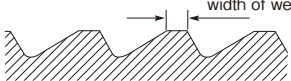
Item	Inspection method	Limit of use	Remedy																																				
Main Body	<p>Visually check or use color dyes to find cracks.</p> <p>Measure for wear or deformation of holes of shackle and screw .</p> <p>Measure the jaw opening.</p>	<p>When found visually.</p> <p>When the diameter of any one part of circumference of hole (D1/D2) exceeds the respective size in the table below.</p> <p>When Jaw opening (L) exceeds the respective size in the table below.</p> <p style="text-align: center;">SCC0.3W•SCC0.5</p>  <table border="1" data-bbox="476 774 901 885"> <thead> <tr> <th>Rated capacity (ton)</th> <th>0.3W</th> <th>0.5</th> <th>1</th> <th>1W</th> <th>1.5</th> <th>3</th> <th>3W</th> <th>6</th> </tr> </thead> <tbody> <tr> <td>D1 (mm)</td> <td>13.5</td> <td>13.5</td> <td>15.5</td> <td>19.5</td> <td>19.5</td> <td>23.5</td> <td>23.5</td> <td>34.5</td> </tr> <tr> <td>D2 (mm)</td> <td>18.0</td> <td>17.0</td> <td>27.5</td> <td>27.5</td> <td>27.5</td> <td>32.3</td> <td>32.3</td> <td>41.8</td> </tr> <tr> <td>L (mm)</td> <td>128</td> <td>51.5</td> <td>35.7</td> <td>113.4</td> <td>37.8</td> <td>58.8</td> <td>85.1</td> <td>85.1</td> </tr> </tbody> </table> <p>When the displacement of the center of Screw and Pad exceeds 2 mm.</p>	Rated capacity (ton)	0.3W	0.5	1	1W	1.5	3	3W	6	D1 (mm)	13.5	13.5	15.5	19.5	19.5	23.5	23.5	34.5	D2 (mm)	18.0	17.0	27.5	27.5	27.5	32.3	32.3	41.8	L (mm)	128	51.5	35.7	113.4	37.8	58.8	85.1	85.1	Discard
Rated capacity (ton)	0.3W	0.5	1	1W	1.5	3	3W	6																															
D1 (mm)	13.5	13.5	15.5	19.5	19.5	23.5	23.5	34.5																															
D2 (mm)	18.0	17.0	27.5	27.5	27.5	32.3	32.3	41.8																															
L (mm)	128	51.5	35.7	113.4	37.8	58.8	85.1	85.1																															
Shackle	<p>Measure wear and deformation at hole.</p>	<p>When the diameter of any one part of circumference of hole (D1) exceeds the respective size in the table below.</p> <p>When the diameter of each part of circumference of any hole becomes smaller than respective size in the table below.</p>  <table border="1" data-bbox="476 1348 901 1452"> <thead> <tr> <th>Rated capacity (ton)</th> <th>0.3W</th> <th>0.5</th> <th>1</th> <th>1W</th> <th>1.5</th> <th>3</th> <th>3W</th> <th>6</th> </tr> </thead> <tbody> <tr> <td>D1 (mm)</td> <td>13.5</td> <td>13.5</td> <td>15.5</td> <td>19.5</td> <td>19.5</td> <td>23.5</td> <td>23.5</td> <td>34.5</td> </tr> <tr> <td>D2 (mm)</td> <td>9.5</td> <td>9.5</td> <td>11.5</td> <td>15.5</td> <td>15.5</td> <td>18.5</td> <td>18.5</td> <td>31.5</td> </tr> <tr> <td>W (mm)</td> <td>16.5</td> <td>16.5</td> <td>23.5</td> <td>27.5</td> <td>27.5</td> <td>32.5</td> <td>32.5</td> <td>52.5</td> </tr> </tbody> </table>	Rated capacity (ton)	0.3W	0.5	1	1W	1.5	3	3W	6	D1 (mm)	13.5	13.5	15.5	19.5	19.5	23.5	23.5	34.5	D2 (mm)	9.5	9.5	11.5	15.5	15.5	18.5	18.5	31.5	W (mm)	16.5	16.5	23.5	27.5	27.5	32.5	32.5	52.5	Replace
Rated capacity (ton)	0.3W	0.5	1	1W	1.5	3	3W	6																															
D1 (mm)	13.5	13.5	15.5	19.5	19.5	23.5	23.5	34.5																															
D2 (mm)	9.5	9.5	11.5	15.5	15.5	18.5	18.5	31.5																															
W (mm)	16.5	16.5	23.5	27.5	27.5	32.5	32.5	52.5																															

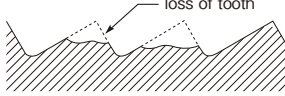
Item	Inspection method	Limit of use	Remedy																		
Support Bolt & Nut (for Shackle)	Measure wear at shank. Visually check for installation condition of nut. (Only for SCC0.3W, SCC0.5)	When the diameter of any one part of circumference of bolt shank becomes smaller than the respective size in the table below. <table border="1" data-bbox="512 240 941 316"> <tr> <td>Rated capacity (ton)</td> <td>0.3W</td> <td>0.5</td> <td>1</td> <td>1W</td> <td>1.5</td> <td>3</td> <td>3W</td> <td>6</td> </tr> <tr> <td>Diameter (mm)</td> <td>11.5</td> <td>11.5</td> <td>13.5</td> <td>17.5</td> <td>17.5</td> <td>21.5</td> <td>21.5</td> <td>32.5</td> </tr> </table> When damaged, loose or disconnected.	Rated capacity (ton)	0.3W	0.5	1	1W	1.5	3	3W	6	Diameter (mm)	11.5	11.5	13.5	17.5	17.5	21.5	21.5	32.5	Replace
Rated capacity (ton)	0.3W	0.5	1	1W	1.5	3	3W	6													
Diameter (mm)	11.5	11.5	13.5	17.5	17.5	21.5	21.5	32.5													
Cotter Pin	Visually check for the attached condition.	When damaged or disconnected.	Replace																		
Screw	Visually check or use color dyes to find cracks. Visually check for bending and scratches. Measure for wear of threads. Check for deformation of handle.	When found visually. When the displacement of the screw center exceeds 2mm. When the movement is not smooth. When the diameter of any circumference of threads becomes smaller than the respective size in the below table. <table border="1" data-bbox="512 866 941 941"> <tr> <td>Rated capacity (ton)</td> <td>0.3W</td> <td>0.5</td> <td>1</td> <td>1W</td> <td>1.5</td> <td>3</td> <td>3W</td> <td>6</td> </tr> <tr> <td>Diameter (mm)</td> <td>19.3</td> <td>17.3</td> <td>29.3</td> <td>29.3</td> <td>29.3</td> <td>34.2</td> <td>34.2</td> <td>43.7</td> </tr> </table> When the handle is damaged.	Rated capacity (ton)	0.3W	0.5	1	1W	1.5	3	3W	6	Diameter (mm)	19.3	17.3	29.3	29.3	29.3	34.2	34.2	43.7	Replace
Rated capacity (ton)	0.3W	0.5	1	1W	1.5	3	3W	6													
Diameter (mm)	19.3	17.3	29.3	29.3	29.3	34.2	34.2	43.7													
Cam	Visually check or measure the degree of wear. Visually check or use color dyes to find cracks at the bottom of teeth. Visually check for broken teeth. Visually check for deformation of stop ring.	When the degree of wear exceeds 0.5mm.  When found visually.  When the broken tooth is found.  When found deformation of stop ring.	Replace																		

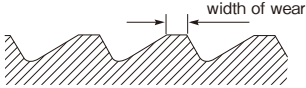
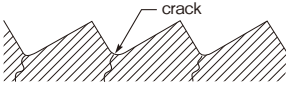
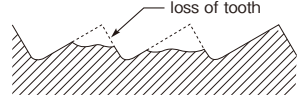
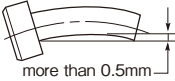
Item	Inspection method	Limit of use	Remedy																		
<p>Pad</p>	<p>Visually check or measure the degree of wear.</p>	<p>When the degree of wear exceeds 0.5mm.</p> 	<p>Replace</p>																		
	<p>Visually check or use color dyes to find cracks at the bottom of teeth.</p>	<p>When found visually.</p> 																			
	<p>Visually check for broken teeth.</p>	<p>When the broken tooth is found.</p> 																			
<p>Bolt & Nylon Nut (for Pad)</p>	<p>Measure wear at Shank.</p>	<p>When the diameter of any circumference of threads becomes smaller than the respective size in the below table.</p> <table border="1" data-bbox="479 826 902 906"> <tr> <td>Rated capacity (ton)</td> <td>0.3W</td> <td>0.5</td> <td>1</td> <td>1W</td> <td>1.5</td> <td>3</td> <td>3W</td> <td>6</td> </tr> <tr> <td>Diameter (mm)</td> <td>3.5</td> <td>3.5</td> <td>5.5</td> <td>5.5</td> <td>5.5</td> <td>5.5</td> <td>5.5</td> <td>7.5</td> </tr> </table>	Rated capacity (ton)	0.3W	0.5	1	1W	1.5	3	3W	6	Diameter (mm)	3.5	3.5	5.5	5.5	5.5	5.5	5.5	7.5	<p>Replace</p>
	Rated capacity (ton)	0.3W	0.5	1	1W	1.5	3	3W	6												
	Diameter (mm)	3.5	3.5	5.5	5.5	5.5	5.5	5.5	7.5												
<p>Visually check or use color dyes to find cracks.</p>	<p>When found visually.</p>																				
<p>Visually check or measure to find bending or deformation.</p>	<p>When bending or deformation exceeds 0.5mm.</p> 																				
<p>Visually check for installation condition.</p>	<p>When damaged, loose or disconnected.</p>																				

