



Structure Clamp

HLC-S

HLC-W

Operation Manual

This operation manual explains the basic operation and handling of the clamps. Please read this manual carefully before use and observe the precautions for safe operation.

SUPER TOOL CO., LTD.



brand lifting clamps are energy-saving lifting equipment which have been developed for the purpose of transporting steel materials.

Proper use

Operate lifting clamps after carefully reading and understanding this instruction manual for enhancing efficiency and safety of operation.

Prime efficiency and economy

Advanced functions, reasonableness and versatile applications of finely and carefully designed  lifting clamps ensure prime efficiency and economy.

Special considerations on safety

We conduct a pulling test with a load three times (or twice) of rated capacity and a manufacturing serial number is marked on each product, thus directing a special attention to safety.

Precautions for safety operation

(Pages 1~10 are common to all lifting clamp models)

Be sure to read this instruction manual carefully before use.

Mistaken use of lifting clamp may cause a danger such as dropping of load.

Education of “crane safety regulations,” “operation manual for lifting clamp,” “your company’s operation standards,” etc. should be given before actual operation not only to business owners who have purchased clamps but also to their operators to ensure that actual operators have acquired enough knowledge, safety information, and precautions of the clamps.

Safety precautions are divided into two classifications in this manual; “Warning” and “Caution,”.



WARNING:

Indicates a potentially hazardous situation which, if not avoided, could result in death or serious injury.





CAUTION:

Indicates a potentially hazardous situation which, if not avoided, could result in medium damage or slight injury, or could result in property damage.

While only mentioned in  CAUTION, failure to comply with them still may lead to a serious disaster. As such, do not fail to pay attention both to WARNING and CAUTION which are of great importance.

Meanings of Signs

The signs of  and  indicate that precautions should be taken. The contents of warning or caution are described at each sign.



The sign of  indicates prohibited actions.

The sign of  indicates that an action is enforced or instructed.







Two point lift for  righthand figure.

※ After reading this manual, make sure to keep it at a place of easy access by any users.







1. Handling in general

 WARNING	
<ul style="list-style-type: none"> ● Do not operate until the contents of the operation manual, and caution tag/plate are thoroughly read and understood. ● Do not operate without a legal qualification. ● Be sure to clear of the area of the operation for lifting or turning a load against possible drop off or fall over. ● Do not use for other than intended purpose. 	 Prohibited
<ul style="list-style-type: none"> ● Make sure to execute an inspection periodically and before each operation. 	 Instructed



2. Check before operation





 WARNING	
<ul style="list-style-type: none"> ● Do not use clamp unsuitable for the operation method. ● Do not use clamp of an abnormal condition; deformed, cracked, worn, malfunctioning, etc. ● If the load is under the following conditions, do not use clamp. (A material of fragile, high-hardness, low-hardness or extremely low-hardness, or a member with the gripping part tapered down more than 8°) 	 Prohibited
<ul style="list-style-type: none"> ● Check the type, rated capacity, clamp range, and “periodic inspection completed” label displayed on clamp body. ● The load to be lifted shall be within an allowable range of rated capacity of clamp. ● Thickness of load shall be within designated clamping range. 	 Instructed
 CAUTION	
<ul style="list-style-type: none"> ● Do not use clamp for the load under the following conditions. (Load to be lifted is more than 150°C, or in an atmosphere or solution of acid or alkaline chemicals less than minus 20°C) 	 Prohibited
<ul style="list-style-type: none"> ● Sling to be used for the clamp shall be an appropriate one for lifting operation. 	 Instructed

3. Lifting operation





 WARNING	
<ul style="list-style-type: none"> ● Do not use clamp, lifting at one point. (excluding special or custom ordered products) ● Do not use the clamp in the following ways of lifting: lifting of two or more individual objects at one time. (overlapped loads, padded load etc. , or side gripping) ● Do not use the clamp for pulling out steel plate sheet from the steel sheet pile or for vertical lifting of the sheet. ● Do not use the clamp when strong wind may threaten to cause any danger. ● Do not use the clamp for a hydraulic shovel. 	 Prohibited
<ul style="list-style-type: none"> ● Install two or more clamps in a balanced way to keep the balance of load. 	 Two point lift
<ul style="list-style-type: none"> ● The lifting angle of the clamps and the dividing angle should be kept within the allowable angles according to types. ● Load should be inserted to the innermost end of the jaw opening. ● When you use the clamp with a lock mechanism, never fail to have the lock engaged. 	 Instructed
 CAUTION	
<ul style="list-style-type: none"> ● If oil, paint, scale, rust, etc. are on the gripping pad, do not use the clamp. ● Do not drop clamp or drag on the ground. 	 Prohibited

4. Operation of a crane

 WARNING	
<ul style="list-style-type: none"> ● Never lift a load exceeding the rated capacity. ● Do not operate a crane in such a way as to give an impact to the load or the clamp. ● Do not allow a person to stand on the load or to carry him. ● Do not lift a load which is not free from any other objects. ● Do not release the lock of clamp while lifting load. ● Avoid unintended contact by load to an adjacent member or to the clamp, which has been removed from the load. 	 Prohibited

<ul style="list-style-type: none"> ● Stop the lifting operation by crane for a moment when the load is applied to the lifting ring for safety checking. (depth of the load into the clamp opening; status of locking). ● Stop the operation of the crane just before the load reaches the ground, and check the following matters: (Inclination or falling over of the load and security around the landing area of the load) 	 Instructed
 CAUTION	
<ul style="list-style-type: none"> ● Do not operate the crane in such a way as to drag the load along the ground. ● Do not leave the crane (or winder, etc.) unattended from an operating position while keeping the load lifted with the clamp. 	 Prohibited
<ul style="list-style-type: none"> ● Raising and lowering operation by crane should be done slowly and carefully. 	 Instructed

5. Maintenance, storage and alteration

 WARNING	
<ul style="list-style-type: none"> ● Never alter the clamp and its accessories. ● Do not apply welding or heat to the clamp or its accessories. ● Do not use any other parts than our company's genuine parts. ● Clamps which require the repair should be stored at a different place so that they are not used mistakenly. 	 Prohibited
<ul style="list-style-type: none"> ● Persons with specialized knowledge designated by the business owner are to conduct maintenance and repairing work. ● When any abnormality with the clamp is found, do not use it and immediately repair or dispose. ● Remove, if any, paint or mud sticking to the moving parts of the clamp, cams, and pads. 	 Instructed
 CAUTION	
<ul style="list-style-type: none"> ● Conduct maintenance and repairing without any load attached. ● Conduct maintenance and repairing after posting a sign indicating that you're on the maintenance work. ● Never fail to lubricate oil on the rotating parts of the clamp (around the pins), guide grooves, sliding parts, etc. ● Be sure to store clamps indoor. 	 Instructed

■ General warning for use (common to all lifting clamp models)

1. Be sure to select proper model clamps for use.

Pay special attentions to keep the lifting direction (rope angle).

2. Confirm the weight of the load. Do not exceed maximum capacity (designated ton) on clamps. (Never overload.)
3. Before use, confirm followings:
 - (a) Proper capacity of clamps.
 - (b) No abnormal movements of clamp or loosening of any bolts.
 - (c) No oil or other foreign matters on the surface of the cam and pad.
4. **Never use for load beyond the clamp range.**
5. When installing clamps, insert a lifting load completely until it comes in contact with the deepest of the jaw opening of main body.
6. **Depending on the model or capacity of the clamp, the cam teeth may not bite a load sufficiently when the load is a hard or light weight material (Less than 1/5 of maximum capacity or less than 1/4 of maximum clamp range). Confirm the condition of clamp for safety.**
7. Confirm that the safety lock is completely engaged in case clamp has a built-in lock.
8. Confirm that the load is well balanced. Determine the clamp position or the center of gravity of the rope properly. It is especially important to determine the horizontal center of gravity.
9. When lifting at 2 points, be sure to use two wire ropes, and make them equal length. (Fig. A)

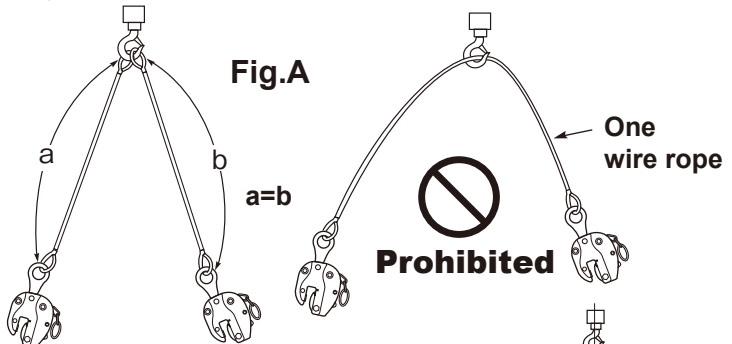

10. When lifting at 2 points, keep the lifting angle within 60°. (Fig. B)

(Follow the standards if lifting angle is specified depending on items.) If the load is long, use a balance.

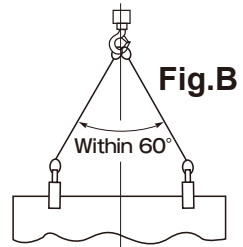

11. Never lift two or more steel plates or steel members at a time.
12. The load may move to an unexpected direction when lifted off the ground and as such confirm the center of gravity and the clamping position for safety when raising. Sufficient caution should be taken until the clamp with the load becomes completely balanced.
13. When changing directions of the load or any similar operations, all personnel must be clear of the area of operation. (Fig. C)

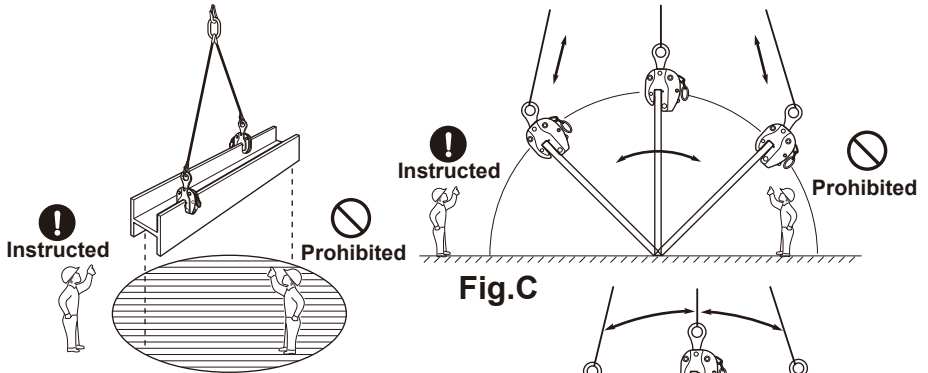

Fig.C

14. Do not ride on the lifting load.
Never use clamp for riding or carrying person.
15. Keep momentary inverting angle of a steel plate within 30°. (Fig. D)

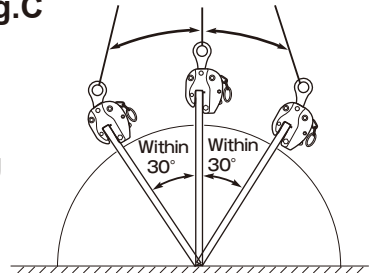

Fig.D

16. **Before operation, the surface of load must always be clean and free of scale, coatings or other foreign matters that will reduce clamping force significantly.**
17. **When raising, special attention must be given to prevent the rope from loosening by its unintended contact with any other objects.**
18. When raising again after the load is put on ground, reconfirm the clamp condition.
19. Do not use clamp for heated load or in a corrosion liquid because safety factor and durability will be reduced in such conditions.
20. Do not alter clamp by welding, cutting by gas or by any other modification.
21. Do not weld electrically a load while being lifted by clamp.
22. Conduct daily maintenance and lubrication.

■ Maintenance and Inspection

1. Maintenance

Daily maintenance is important for efficient and safe operation even under the severe use condition and for such purposes, please comply with the followings.

- (1) Designate the use standards and control.
- (2) Keep clamps indoor and do not leave them outdoor.
- (3) Check the followings to maintain in a good condition.
 - (a) Operating condition.
 - (b) Any abrasion, damage, or clogging at teeth of cam and pad.
 - (c) Deformation of main body - at jaw opening in particular.
- (4) Separate conforming clamps and other hazardous items identified during use or inspection and designate the defective sections. Perform maintenance any soon.
- (5) For the storage, place soft material as wooden chip in-between cam and pad to protect the teeth.
- (6) Perform inspection and maintenance once a week by referring to "Inspection Standards". Lubricate sliding sections periodically. (However, remove oil at teeth of cam and pad.)

2. Periodic Inspection

Perform periodic inspection in accordance with the periodic inspection and maintenance standards. Functions and life of clamps may differ in a great degree as they are used in varieties of fields under different conditions of use. Therefore, preparation and practice of effective handling/inspection standards manual by users themselves are recommended. We ask you to establish complete maintenance and control for assurance of safety in reference to our Manufacturer's Inspection Standards of our clamp. Clamp is designed for easy replacement of parts and therefore, do not fail to replace defective parts. Also, keeping spare parts at all times is recommended. For your preparation of the standards, pay special attention to the followings.

- (1) Operation and maintenance standards
 - (a) Preparation of use criteria (shape of load and operating methods).
 - (b) Thorough understanding and compliance of cautions on handling.
 - (c) Maintenance and storage.
 - (d) Rules of inspection and check at site.

- (2) Standards on periodic inspection
 - (A) Establishing dates of periodic inspection.
 - (B) Establishing inspection and maintenance methods.
 - (a) Inspecting period.
 - (b) Person in charge of the inspection.
 - (c) Inspection site.
 - (d) Tools and devices for inspection.
 - (e) Establishment of permissible limit of use.
 - (f) Explicit designation of maintenance and repair methods.

3. Manufacturer's inspection method

Our company's inspection procedures are as follow.

Check for

- (1) Movements.
- (2) Wear, loss, and/or clogging of/at the teeth of the cam and screw.
- (3) Deformation of main body.
- (4) Deformation of shackle.
- (5) The status of bolts, pins, links and springs.
- (6) Deep scratches in general.
- (7) Other checking items based on the Standards.

Lifting angle and rated load of wire rope

The maximum rated capacity of wire ropes also differs according to the lifting angle. Therefore, after paying attention to the lifting angle, always use wire ropes with the appropriate diameter.

Correlation table between the lifting angle and the applicable load for wire rope (for 2-point lifting)

■ JIS G 3525 6×24 A type

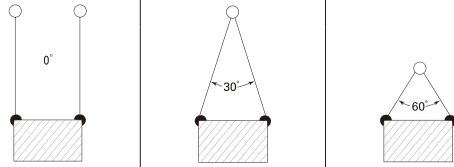
D wire rope diameter (mm)	W rated load (for 1 single rope) [Safety factor S=6] (ton)			
		(Change in % of the lifting capacity rate according to the lifting angle)		
		100%	96%	86%
Maximum allowable load (rated load) for 2 wire ropes (ton)				
6	0.30	0.60	0.57	0.51
8	0.53	1.07	1.03	0.92
9	0.67	1.35	1.30	1.16
10	0.83	1.67	1.61	1.44
12	1.20	2.41	2.32	2.08
14	1.64	3.28	3.15	2.83
16	2.14	4.28	4.12	3.69
18	2.72	5.44	5.23	4.69
20	3.35	6.70	6.44	5.77
22	4.06	8.12	7.81	7.00
24	4.82	9.65	9.28	8.32
26	5.66	11.3	10.8	9.76
28	6.58	13.1	12.6	11.3
30	7.55	15.1	14.5	13.0
32	8.58	17.1	16.5	14.8
36	10.8	21.7	20.8	18.7
40	13.4	26.8	25.8	23.1

Calculation formula of a wire rope diameter and rated load (for 1 single rope)

* Refer to the calculated values as rough indications.

① $D = \sqrt{W \times C}$

② $W = \frac{D^2}{C}$

D= wire rope dia. (mm)
W= rated load (ton)
C= 120 (constant)
(with Safety factor S = 6)

★ When looking for the required wire rope diameter to lift a 3 ton load

① $D = \sqrt{W \times C}$

$D = \sqrt{3 \times 120} = \sqrt{360} = 19 \rightarrow$

20mm

★ When looking for the maximum capacity (rated load) of a wire rope with 12mm diameter

② $W = \frac{D^2}{C}$

$W = \frac{12^2}{120} = \frac{144}{120} = 1.2 \rightarrow$

1.2ton



Structure Clamp

HLC-S

HLC-W

Operation Manual and Inspection Standards



Structure Clamp

HLC-S HLC-W

■ Uses

Special clamps for lateral lifting and transporting steel structures (H beam, I beam, T beam, L beam, etc. and their combined structures).

■ Features

1. The clamping force increases in proportion to the lifting load and clamps firmly.
- 2 Even after the load lands and the wire loosens, the clamp does not come off, because the constant initial load always works by a spring.
3. The main parts are the mold die-forging products of special alloy steel processed with optimal heat treatment, and thus, strong and durable.

■ Specifications

Item No.	Rated Capacity (ton)	Clamp Range (mm)	Inner diameter of shackle hole (mm)	Net Weight (kg)
HLC0.5S	0.5	1~13	23	1.3
HLC1S	1	1~13	23	1.5
HLC1W	1	2~20	46	2.5
HLC2S	2	3~22	30	3.7
HLC3S	3	12~35	36	8.1

REPLACEMENT PARTS AND ASSEMBLIES

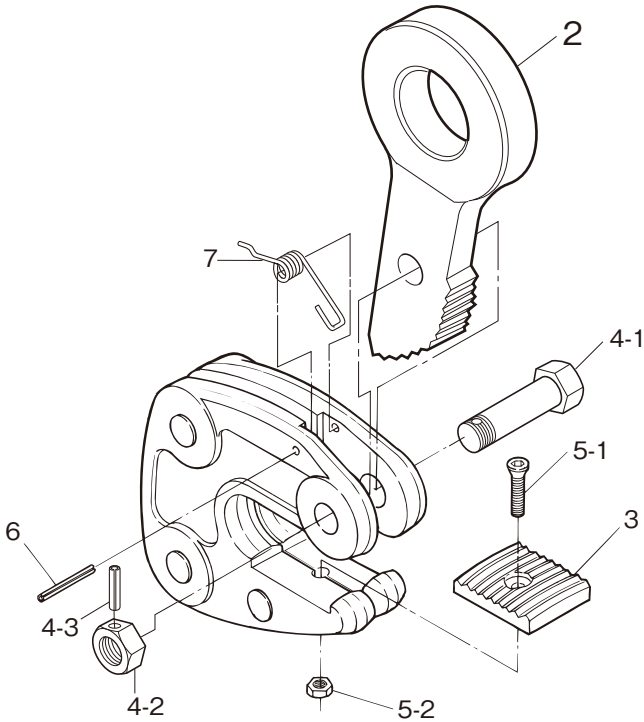

Part No.	Part Name	Item No.	Set Q'ty
2	Cam Assembly	HLCT	1
	Support Bolt/Nut(for Cam)	HLK	
4-1	Support Bolt(for Cam)	HLCK	1
4-2	Nut(for Cam)		1
4-3	Spring Pin(for Support Bolt)	HLCC	1

Part No.	Part Name	Item No.	Set Q'ty
	Pad Assembly	HLA	
3	Pad	HLCA	1
5-1	Bolt(for Pad)	HLCN	1
5-2	Nylon Nut(for Pad)		1
	Spring	HLS	
7	Spring	HLCS	1
6	Spring Pin(for Spring)	HLCQ	※1 (2)

※2 pcs only for HLC0.5S

Attention:

- When ordering, specify the rated capacity (ton) of Item No. and S or W.
(For instance, the cam assembly for HLC2S is HLCT2S. The pad for HLC1W is HLCA1W.)
- Periodic lubrication is required at the pin and the sliding section.
(Please remove oil from the pad and cam teeth.)

■ How to use

1. OPERATION METHOD

- ① Tilt the cam in the direction of the arrow and push it in until the end of the lifting load comes into contact with the deepest section of the opening.
- ② Clamp the lifting load and the opening so that they are parallel.
- ③ When removing the lifting load, pull out the main body while tilting the cam in the direction of the arrow.

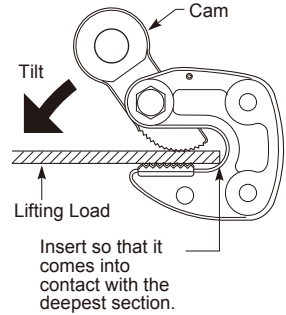

2. METHOD OF USE FOR LIFTING

- ① The direction of the wire rope when lifting should be within the range shown in the figure on the right.

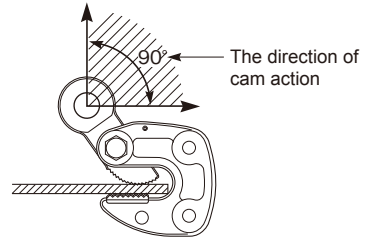

- ② The cam cannot be lifted in the direction where the shaft center of the cam is aligned with the wire rope. (The clamping force does not work on the lifting load and may cause the load to fall.)

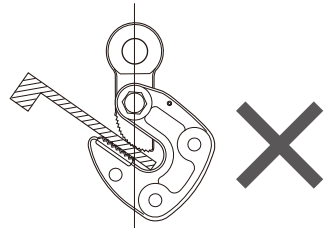

- ③ Be sure to lift the load at 2 points, and use a balance if possible. The length of each wire rope must be equally divided.

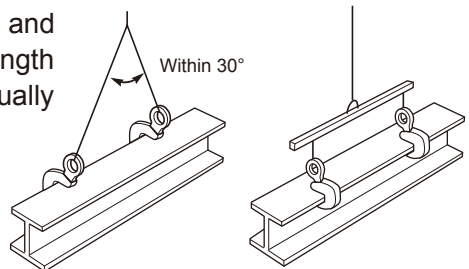

- ④ If the load is lifted at an angle, the clamp should be inclined at an angle of up to 45°.

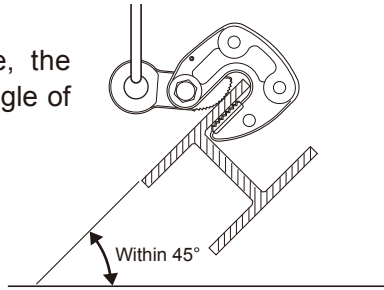

- ⑤ The clamps can also be used for temporary turning over H steel, etc.

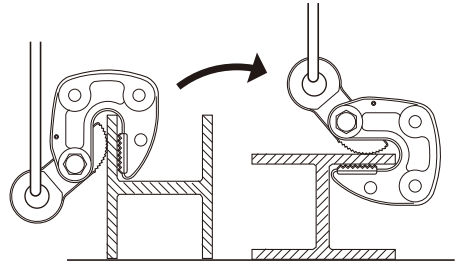

- ⑥ Even with 2 or 4 points lifting, horizontal lifting of steel plates and flat plates is not possible.

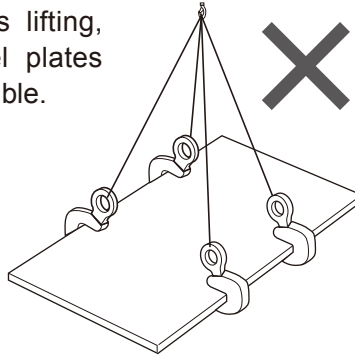

- ⑦ Vertical lifting is not possible with this clamp. For vertical lifting, be sure to use vertical lifting clamps or screw cam clamps.

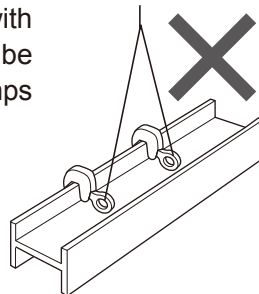

3. DISASSEMBLING AND ASSEMBLING

① Cam and others

1) Disassembling

Remove the spring pin holding the support bolt and nut with a pin punch or the like, loosen the nut, and remove the support bolt. Remove the spring pin holding the spring with a pin punch or the like and take out the spring.

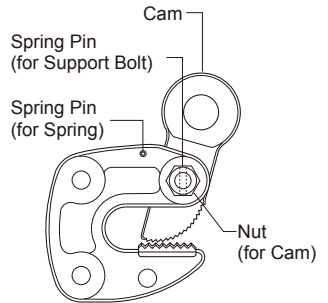

2) Assembling

Perform the reverse procedure of disassembling.

② Pad

1) Disassembling

Remove the pad with a hex wrench that fits the bolt holding the pad.

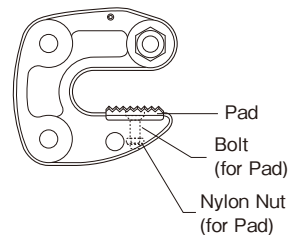

2) Assembling

Perform the reverse procedure of disassembling.

■ CAUTION:

- ◆ Use within the rated capacity.
- ◆ Use within the clamp range.
- ◆ Do not use for any objects other than steel materials.
- ◆ Do not use for hard (30 HRC or higher) load.
- ◆ Lifting is not allowed for a load tapering down in upward direction.
- ◆ Do not apply shock to the load or lifting clamp.
- ◆ When using a loaded clamp again without reinstalling it, be sure to retighten torque by the specified torque.
- ◆ Do not lift more than one plate.
- ◆ Before using the product, be sure to check for clogging and wear of the teeth of the cam, screw and any other parts.
- ◆ Do not alter. Heating, modifying, etc. will significantly reduce the quality (strength).

■ OTHER:



- ◆ Inquiries for Repair Parts and Repair.
If repair parts or repairs are required, stop using this clamp and contact your distributor.

■ DAILY INSPECTION:

Conduct daily checks and maintenance to prevent the loss of safety and efficiency.

1. Check that there are no cracks at the body, cam, or wire rope holes.
2. Check if the movement and lubrication condition of each part are good.
3. **Check for wear, loss, or clogging of the teeth of the cam and screw.**
4. Refer to other inspection standards.

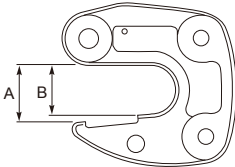
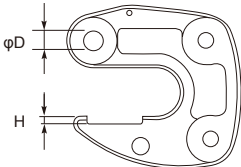
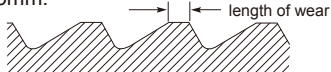
INSPECTION STANDARDS FOR HLC-S/W

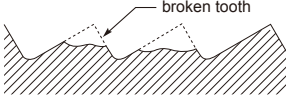
Item	Inspection method	Limit of use	Remedy													
<p style="text-align: center;">Main Body</p>	<p>Visually check or use color dyes to find cracks. Measure the jaw opening.</p>	<p>When visually found.</p> <p>When the difference of "A" and "B" exceeds 2.5%. (2.5mm or more against 100mm in depth.)</p> 	Discard													
	<p>Measure the wear or deformation of support bolt hole or pad installing section.</p> <p>Visually check to find deformation or rattle.</p>	<p>When the diameter of any one part of circumference of any hole exceeds the respective size of "D" in the table below. When the pad installing section is below the dimension "H".</p>  <table border="1" data-bbox="580 869 932 954"> <thead> <tr> <th>Rated Capacity (ton)</th> <th>0.5</th> <th>1</th> <th>2</th> <th>3</th> </tr> </thead> <tbody> <tr> <td>D (mm)</td> <td>12.5</td> <td>14.5</td> <td>19.5</td> <td>23.5</td> </tr> <tr> <td>H (mm)</td> <td>3.5</td> <td>3.5</td> <td>4.0</td> <td>4.5</td> </tr> </tbody> </table> <p>When the caulking of the main body is loose and rattling.</p>		Rated Capacity (ton)	0.5	1	2	3	D (mm)	12.5	14.5	19.5	23.5	H (mm)	3.5	3.5
Rated Capacity (ton)	0.5	1	2	3												
D (mm)	12.5	14.5	19.5	23.5												
H (mm)	3.5	3.5	4.0	4.5												
<p style="text-align: center;">Cam</p>	<p>Visually check or measure the degree of wear.</p>	<p>When the degree of wear exceeds 0.5mm.</p> 	Replace													
	<p>Visually check or use color dyes to find cracks at the bottom cam teeth.</p>	<p>When found visually.</p> 														
	<p>Visually check for broken cam teeth.</p>	<p>When any broken tooth is found.</p> 														

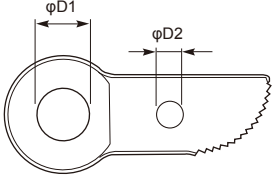
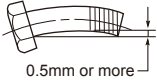
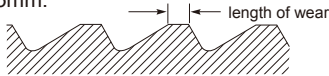
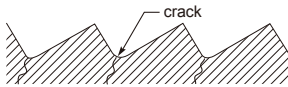
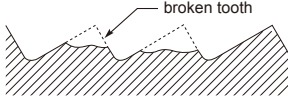
Item	Inspection method	Limit of use	Remedy																		
<p style="text-align: center;">Cam</p>	<p>Measure to find the wear or deformation of inner diameter of lifting ring.</p>	<p>When the diameter of any one part of circumference of any hole exceeds the respective size in the table below.</p>  <table border="1" data-bbox="543 448 904 528"> <thead> <tr> <th>Rated Capacity (ton)</th> <th>0.5S</th> <th>1S</th> <th>1W</th> <th>2S</th> <th>3S</th> </tr> </thead> <tbody> <tr> <td>D1 (mm)</td> <td>24.0</td> <td>24.0</td> <td>47.0</td> <td>31.0</td> <td>37.0</td> </tr> <tr> <td>D2 (mm)</td> <td>12.5</td> <td>14.5</td> <td>14.5</td> <td>19.5</td> <td>23.5</td> </tr> </tbody> </table>	Rated Capacity (ton)	0.5S	1S	1W	2S	3S	D1 (mm)	24.0	24.0	47.0	31.0	37.0	D2 (mm)	12.5	14.5	14.5	19.5	23.5	<p style="text-align: center;">Replace</p>
	Rated Capacity (ton)	0.5S	1S	1W	2S	3S															
D1 (mm)	24.0	24.0	47.0	31.0	37.0																
D2 (mm)	12.5	14.5	14.5	19.5	23.5																
<p style="text-align: center;">Support Bolt & Nut (for Cam)</p>	<p>Measure the shaft part of bolt for wear.</p> <p>Visually check or use color dyes to find cracks.</p> <p>Visually check or measure to find deformation.</p> <p>Visually check the installation condition of nut and spring pin.</p>	<p>When the diameter of any one part of circumference of any hole exceeds the respective size in the table below.</p> <table border="1" data-bbox="565 635 882 687"> <thead> <tr> <th>Rated Capacity (ton)</th> <th>0.5</th> <th>1</th> <th>2</th> <th>3</th> </tr> </thead> <tbody> <tr> <td>Diameter (mm)</td> <td>11.5</td> <td>13.5</td> <td>18.5</td> <td>22.5</td> </tr> </tbody> </table> <p>When found visually.</p> <p>When the degree of deformation exceeds 0.5mm.</p>  <p>When damaged, loose, or disconnected.</p>	Rated Capacity (ton)	0.5	1	2	3	Diameter (mm)	11.5	13.5	18.5	22.5	<p style="text-align: center;">Replace</p>								
	Rated Capacity (ton)	0.5	1	2	3																
Diameter (mm)	11.5	13.5	18.5	22.5																	
<p style="text-align: center;">Pad</p>	<p>Visually check or measure the degree of wear.</p> <p>Visually check or use color dyes to find cracks at the bottom cam teeth.</p> <p>Visually check for broken cam teeth.</p>	<p>When the degree of wear exceeds 0.5mm.</p>  <p>When found visually.</p>  <p>When any broken tooth is found.</p> 	<p style="text-align: center;">Replace</p>																		

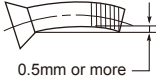
Item	Inspection method	Limit of use	Remedy												
<p>Bolt& Nylon Nut (for Pad)</p>	<p>Measure the shaft part of bolt for wear.</p>	<p>When the diameter of any one part of circumference of any hole exceeds the respective size in the table below.</p> <table border="1" data-bbox="576 240 938 323"> <thead> <tr> <th data-bbox="576 240 688 292">Rated Capacity (ton)</th> <th data-bbox="688 240 736 292">0.5S</th> <th data-bbox="736 240 785 292">1S</th> <th data-bbox="785 240 833 292">1W</th> <th data-bbox="833 240 881 292">2S</th> <th data-bbox="881 240 938 292">3S</th> </tr> </thead> <tbody> <tr> <td data-bbox="576 292 688 323">Diameter (mm)</td> <td data-bbox="688 292 736 323">5.5</td> <td data-bbox="736 292 785 323">5.5</td> <td data-bbox="785 292 833 323">5.5</td> <td data-bbox="833 292 881 323">7.5</td> <td data-bbox="881 292 938 323">9.5</td> </tr> </tbody> </table>	Rated Capacity (ton)	0.5S	1S	1W	2S	3S	Diameter (mm)	5.5	5.5	5.5	7.5	9.5	<p>Replace</p>
	Rated Capacity (ton)	0.5S	1S	1W	2S	3S									
	Diameter (mm)	5.5	5.5	5.5	7.5	9.5									
<p>Visually check or use color dyes to find cracks.</p>	<p>When found visually.</p>														
<p>Visually check or measure to find deformation.</p>	<p>When the degree of deformation exceeds 0.5mm.</p> 														
	<p>Visually check the installation condition of nut.</p>	<p>When damaged, loose, or disconnected.</p>													
<p>Spring</p>	<p>Check if a constant initial load is always applied when the cam is closed.</p>	<p>When there is no appropriate repulsive force when the cam is moved near the minimum clamping range.</p>	<p>Replace</p>												
	<p>Check if an appropriate load is applied when the cam is extended to the maximum clamping range.</p>	<p>When there is no appropriate repulsive force when the cam is moved near the maximum clamping range.</p>													
	<p>Check for the missing or looseness of spring pin.</p>	<p>When the spring pin is missing or loose.</p>													

