

BUC240N

INTERNAL EXPANDING LIFTING CLAMP FOR U SHAPED GUTTER
(Pad Type with Wire Rope and Ring)

CHECK!



PDF of Catalogue

Example of use ⚠ For long gutters, always use a balance and lift at 2 or more points for safety.

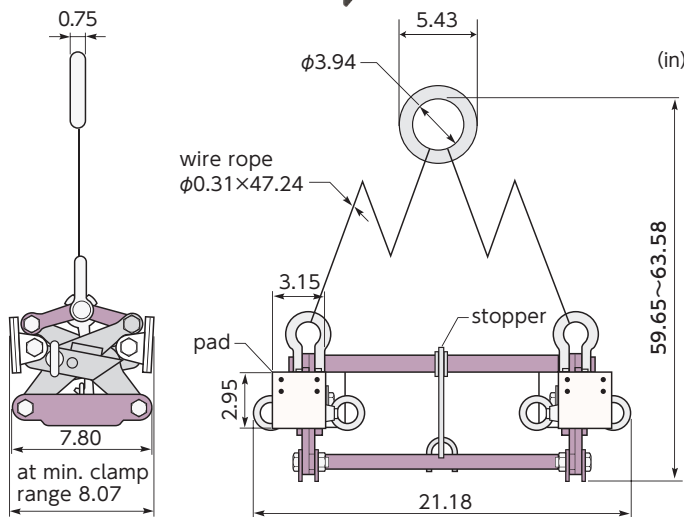
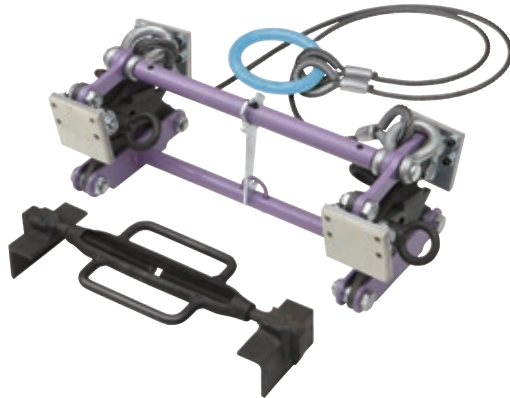
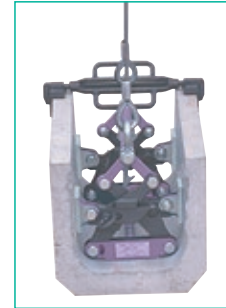

Features

- For JIS reinforced concrete U shaped gutters and JIS drop-lid type U shaped gutters (only 250 / 300A).
- Dedicated for lifting concrete U shaped underground cable box (adjustable clamp range type).
- Including a holder for preventing the cracking of U shaped gutter.
- The inside clamping avoids touching the alignment levelling strings, and makes unnecessary to leave a clearance space outside the workpiece.
- The spike design of the special rubber pads allows to grip firmly the load (can also be used as non-marring type).
- Applicable type of workpieces : JIS U shaped gutter 240, 300A/B/C and JIS drop-lid type 250, 300A, up to 78.74in length.

Cracking prevention holder

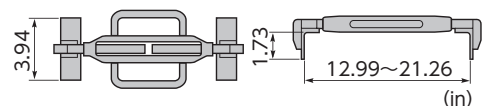

How to use

1) Preparation for lifting

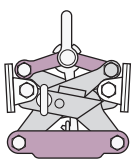

Releasing lock position

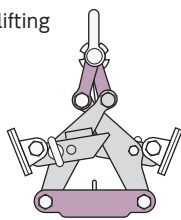

Not in releasing lock position

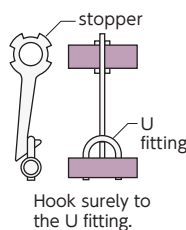

Hook surely to the U fitting.

Lift the clamp to check if the clamp is in releasing lock position as shown in the drawing above. If not, hook the stopper to the main body U fitting and lift again so that the clamp gets in releasing lock position.

2) Setting to the U shaped gutter

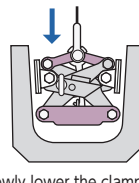

Slowly lower the clamp in releasing lock position until the bottom of the gutter.

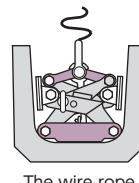

The wire rope is completely loosened.

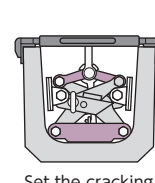

Set the cracking prevention holder.

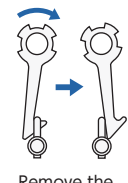

Remove the stopper from the U fitting.

Position the clamp in releasing lock position above the U shaped gutter and land it to the bottom of the gutter until the wire is completely loosened. Next, set the cracking prevention holder just beside the clamp. Here, rotate the knob of the holder to make the arm firmly hold the U shaped gutter. Next, remove the stopper from the U fitting, and then the load can be lifted.

3) Lifting

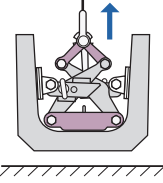

When the load is lifted, the clamp gets automatically into tightening position. When you hoist the crane, the U shaped gutter is firmly gripped and lifted.

4) Moving and landing

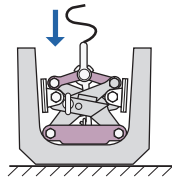

After moving the U shaped gutter to the target place and confirming that it is stable, hoist down until the wire rope is completely loosened.

5) Clamp removing

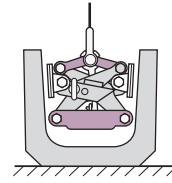

Hook the stopper to the U fitting and lift again to set the clamp in releasing lock position and then you can move the clamp alone to the next load to be operated.

Item No.	Rated capacity (lb)	Clamp range (in)	N.W. (lb)
BUC240N	1102.31	Level 1 8.66 ~ 9.45	26.46
		Level 2 10.24 ~ 11.42	

* Parts drawings and operation manuals can be downloaded from our website.
● For all the appendix, please refer to P.54 ~56