



# **Screw Cam Clamp**

**(J Type)**

# **SJC**

## **Operation Manual**

This operation manual explains the basic operation and handling of the clamps. Please read this manual carefully before use and observe the precautions for safe operation.

**SUPER TOOL CO., LTD.**

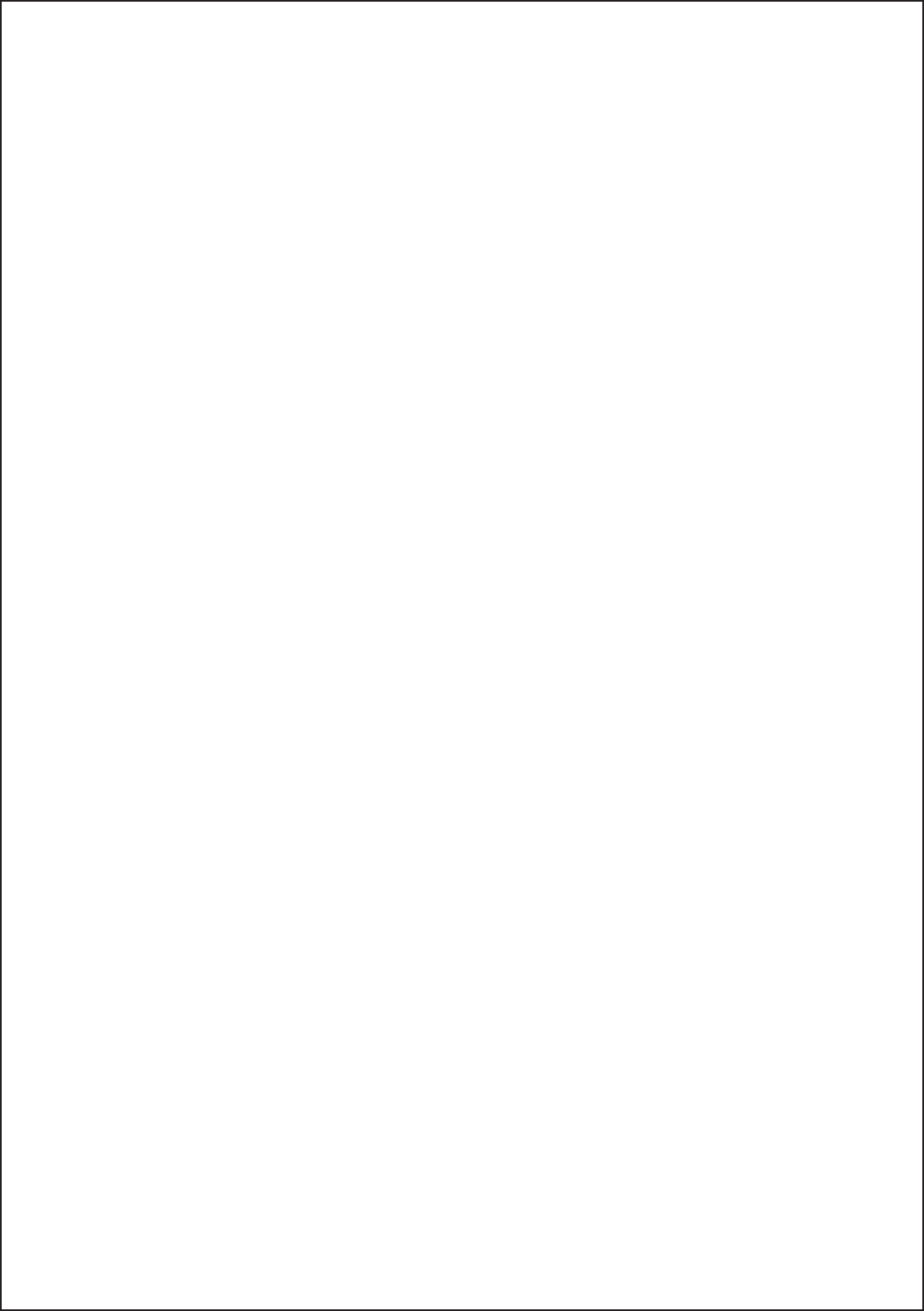



brand lifting clamps are energy-saving lifting equipment which have been developed for the purpose of transporting steel materials.

## **Proper use**

Operate lifting clamps after carefully reading and understanding this instruction manual for enhancing efficiency and safety of operation.

## **Prime efficiency and economy**

Advanced functions, reasonableness and versatile applications of finely and carefully designed  lifting clamps ensure prime efficiency and economy.

## **Special considerations on safety**

We conduct a pulling test with a load three times (or twice) of rated capacity and a manufacturing serial number is marked on each product, thus directing a special attention to safety.

# Precautions for safety operation

(Pages 1~10 are comon to all lifting clamp models)

## Be sure to read this instruction manual carefully before use.

Mistaken use of lifting clamp may cause a danger such as dropping of load.

Education of “crane safety regulations,” “operation manual for lifting clamp,” “your company’s operation standards,” etc. should be given before actual operation not only to business owners who have purchased clamps but also to their operators to ensure that actual operators have acquired enough knowledge, safety information, and precautions of the clamps.

Safety precautions are divided into two classifications in this manual; “Warning” and “Caution,”.



### **WARNING:**

Indicates a potentially hazardous situation which, if not avoided, could result in death or serious injury.



### **CAUTION:**

Indicates a potentially hazardous situation which, if not avoided, could result in medium damage or slight injury, or could result in property damage.

While only mentioned in  $\triangle$ CAUTION, failure to comply with them still may lead to a serious disaster. As such, do not fail to pay attention both to WARNING and CAUTION which are of great importance.

## Meanings of Signs

The signs of  $\diamond$  and  $\triangle$  indicate that precautions should be taken.

The contents of warning or caution are described at each sign.



The sign of  $\circ$  indicates prohibited actions.

The sign of  $\bullet$  indicates that an action is enforced or instructed.







Two point lift for  $\circ$  righthand figure.

※ After reading this manual, make sure to keep it at a place of easy access by any users.







# 1. Handling in general

 <b>WARNING</b>	
<ul style="list-style-type: none"> <li>● Do not operate until the contents of the operation manual, and caution tag/plate are thoroughly read and understood.</li> <li>● Do not operate without a legal qualification.</li> <li>● Be sure to clear of the area of the operation for lifting or turning a load against possible drop off or fall over.</li> <li>● Do not use for other than intended purpose.</li> </ul>	 Prohibited
<ul style="list-style-type: none"> <li>● Make sure to execute an inspection periodically and before each operation.</li> </ul>	 Instructed



# 2. Check before operation

 <b>WARNING</b>	
<ul style="list-style-type: none"> <li>● Do not use clamp unsuitable for the operation method.</li> <li>● Do not use clamp of an abnormal condition; deformed, cracked, worn, malfunctioning, etc.</li> <li>● If the load is under the following conditions, do not use clamp. (A material of fragile, high-hardness, low-hardness or extremely low-hardness, or a member with the gripping part tapered down more than 8°)</li> </ul>	 Prohibited
<ul style="list-style-type: none"> <li>● Check the type, rated capacity, clamp range, and “periodic inspection completed” label displayed on clamp body.</li> <li>● The load to be lifted shall be within an allowable range of rated capacity of clamp.</li> <li>● Thickness of load shall be within designated clamping range.</li> </ul>	 Instructed
 <b>CAUTION</b>	
<ul style="list-style-type: none"> <li>● Do not use clamp for the load under the following conditions. (Load to be lifted is more than 150°C, or in an atmosphere or solution of acid or alkaline chemicals less than minus 20°C)</li> </ul>	 Prohibited
<ul style="list-style-type: none"> <li>● Sling to be used for the clamp shall be an appropriate one for lifting operation.</li> </ul>	 Instructed

### 3. Lifting operation



 <b>WARNING</b>	
<ul style="list-style-type: none"><li>● Do not use clamp, lifting at one point. (excluding special or custom ordered products)</li><li>● Do not use the clamp in the following ways of lifting: lifting of two or more individual objects at one time. (overlapped loads, padded load etc. , or side gripping)</li><li>● Do not use the clamp for pulling out steel plate sheet from the steel sheet pile or for vertical lifting of the sheet.</li><li>● Do not use the clamp when strong wind may threaten to cause any danger.</li><li>● Do not use the clamp for a hydraulic shovel.</li></ul>	 Prohibited
<ul style="list-style-type: none"><li>● Install two or more clamps in a balanced way to keep the balance of load.</li></ul>	 Two point lift
<ul style="list-style-type: none"><li>● The lifting angle of the clamps and the dividing angle should be kept within the allowable angles according to types. Load should be inserted to the innermost end of the jaw opening.</li><li>● When you use the clamp with a lock mechanism, never fail to have the lock engaged.</li></ul>	 Instructed
 <b>CAUTION</b>	
<ul style="list-style-type: none"><li>● If oil, paint, scale, rust, etc. are on the gripping pad, do not use the clamp.</li><li>● Do not drop clamp or drag on the ground.</li></ul>	 Prohibited

### 4. Operation of a crane

 <b>WARNING</b>	
<ul style="list-style-type: none"><li>● Never lift a load exceeding the rated capacity.</li><li>● Do not operate a crane in such a way as to give an impact to the load or the clamp.</li><li>● Do not allow a person to stand on the load or to carry him.</li><li>● Do not lift a load which is not free from any other objects.</li><li>● Do not release the lock of clamp while lifting load.</li><li>● Avoid unintended contact by load to an adjacent member or to the clamp, which has been removed from the load.</li></ul>	 Prohibited



<ul style="list-style-type: none"> <li>● Stop the lifting operation by crane for a moment when the load is applied to the lifting ring for safety checking. (depth of the load into the clamp opening; status of locking).</li> <li>● Stop the operation of the crane just before the load reaches the ground, and check the following matters: (Inclination or falling over of the load and security around the landing area of the load)</li> </ul>	 Instructed
---	--

 **CAUTION**

<ul style="list-style-type: none"> <li>● Do not operate the crane in such a way as to drag the load along the ground.</li> <li>● Do not leave the crane (or winder, etc.) unattended from an operating position while keeping the load lifted with the clamp.</li> </ul>	 Prohibited
<ul style="list-style-type: none"> <li>● Raising and lowering operation by crane should be done slowly and carefully.</li> </ul>	 Instructed

## 5. Maintenance, storage and alteration

 **WARNING**

<ul style="list-style-type: none"> <li>● Never alter the clamp and its accessories.</li> <li>● Do not apply welding or heat to the clamp or its accessories.</li> <li>● Do not use any other parts than our company's genuine parts.</li> <li>● Clamps which require the repair should be stored at a different place so that they are not used mistakenly.</li> </ul>	 Prohibited
<ul style="list-style-type: none"> <li>● Persons with specialized knowledge designated by the business owner are to conduct maintenance and repairing work.</li> <li>● When any abnormality with the clamp is found, do not use it and immediately repair or dispose.</li> <li>● Remove, if any, paint or mud sticking to the moving parts of the clamp, cams, and pads.</li> </ul>	 Instructed

 **CAUTION**

<ul style="list-style-type: none"> <li>● Conduct maintenance and repairing without any load attached.</li> <li>● Conduct maintenance and repairing after posting a sign indicating that you're on the maintenance work.</li> <li>● Never fail to lubricate oil on the rotating parts of the clamp (around the pins), guide grooves, sliding parts, etc.</li> <li>● Be sure to store clamps indoor.</li> </ul>	 Instructed
---	--

## ■ General warning for use (comon to all lifting clamp models)

1. **Be sure to select proper model clamps for use.**  
**Pay special attentions to keep the lifting direction (rope angle).**
2. Confirm the weight of the load. Do not exceed maximum capacity (designated ton) on clamps. (Never overload.)
3. Before use, confirm followings:
  - (a) Proper capacity of clamps.
  - (b) No abnormal movements of clamp or loosening of any bolts.
  - (c) No oil or other foreign matters on the surface of the cam and pad.
4. **Never use for load beyond the clamp range.**
5. When installing clamps, insert a lifting load completely until it comes in contact with the deepest of the jaw opening of main body.
6. **Depending on the model or capacity of the clamp, the cam teeth may not bite a load sufficiently when the load is a hard or light weight material (Less than 1/5 of maximum capacity or less than 1/4 of maximum clamp range). Confirm the condition of clamp for safety.**
7. Confirm that the safety lock is completely engaged in case clamp has a built-in lock.
8. Confirm that the load is well balanced. Determine the clamp position or the center of gravity of the rope properly. It is especially important to determine the horizontal center of gravity.
9. When lifting at 2 points, be sure to use two wire ropes, and make them equal length. (Fig. A)

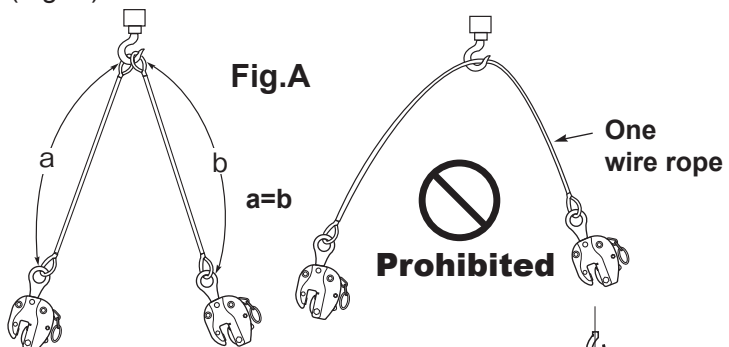

10. When lifting at 2 points, keep the lifting angle within 60°. (Fig. B)  
(Follow the standards if lifting angle is specified depending on items.) If the load is long, use a balance.

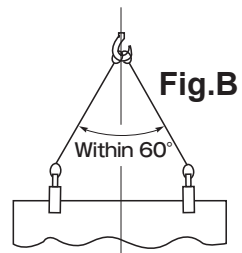



11. Never lift two or more steel plates or steel members at a time.
12. The load may move to an unexpected direction when lifted off the ground and as such confirm the center of gravity and the clamping position for safety when raising. Sufficient caution should be taken until the clamp with the load becomes completely balanced.
13. When changing directions of the load or any similar operations, all personnel must be clear of the area of operation. (Fig. C)

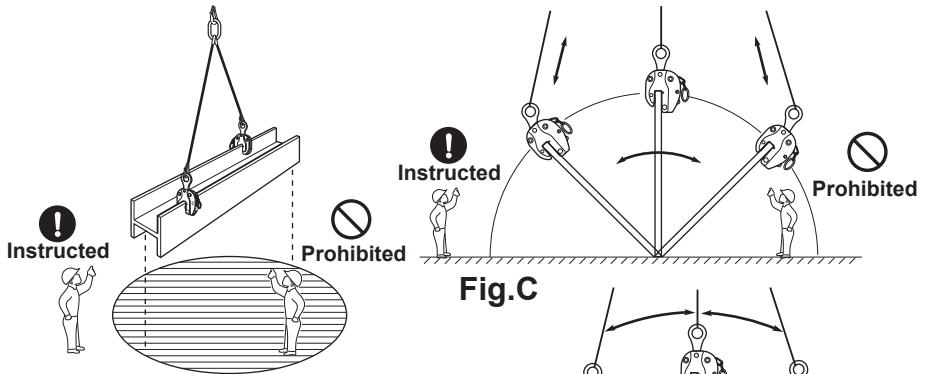

**Fig.C**

14. Do not ride on the lifting load.  
Never use clamp for riding or carrying person.
15. Keep momentary inverting angle of a steel plate within 30°. (Fig. D)

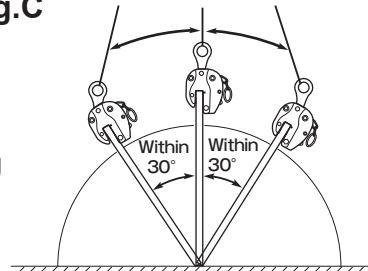

**Fig.D**

16. **Before operation, the surface of load must always be clean and free of scale, coatings or other foreign matters that will reduce clamping force significantly.**
17. **When raising, special attention must be given to prevent the rope from loosening by its unintended contact with any other objects.**
18. When raising again after the load is put on ground, reconfirm the clamp condition.
19. Do not use clamp for heated load or in a corrosion liquid because safety factor and durability will be reduced in such conditions.
20. Do not alter clamp by welding, cutting by gas or by any other modification.
21. Do not weld electrically a load while being lifted by clamp.
22. Conduct daily maintenance and lubrication.

# ■ Maintenance and Inspection

## 1. Maintenance

Daily maintenance is important for efficient and safe operation even under the severe use condition and for such purposes, please comply with the followings.

- (1) Designate the use standards and control.
- (2) Keep clamps indoor and do not leave them outdoor.
- (3) Check the followings to maintain in a good condition.
  - (a) Operating condition.
  - (b) Any abrasion, damage, or clogging at teeth of cam and pad.
  - (c) Deformation of main body - at jaw opening in particular.
- (4) Separate conforming clamps and other hazardous items identified during use or inspection and designate the defective sections. Perform maintenance any soon.
- (5) For the storage, place soft material as wooden chip in-between cam and pad to protect the teeth.
- (6) Perform inspection and maintenance once a week by referring to "Inspection Standards". Lubricate sliding sections periodically. (However, remove oil at teeth of cam and pad.)

## 2. Periodic Inspection

Perform periodic inspection in accordance with the periodic inspection and maintenance standards. Functions and life of clamps may differ in a great degree as they are used in varieties of fields under different conditions of use. Therefore, preparation and practice of effective handling/inspection standards manual by users themselves are recommended. We ask you to establish complete maintenance and control for assurance of safety in reference to our Manufacturer's Inspection Standards of our clamp. Clamp is designed for easy replacement of parts and therefore, do not fail to replace defective parts. Also, keeping spare parts at all times is recommended. For your preparation of the standards, pay special attention to the followings.

- (1) Operation and maintenance standards
  - (a) Preparation of use criteria (shape of load and operating methods).
  - (b) Thorough understanding and compliance of cautions on handling.
  - (c) Maintenance and storage.
  - (d) Rules of inspection and check at site.

- (2) Standards on periodic inspection
  - (A) Establishing dates of periodic inspection.
  - (B) Establishing inspection and maintenance methods.
    - (a) Inspecting period.
    - (b) Person in charge of the inspection.
    - (c) Inspection site.
    - (d) Tools and devices for inspection.
    - (e) Establishment of permissible limit of use.
    - (f) Explicit designation of maintenance and repair methods.

### **3. Manufacturer's inspection method**

Our company's inspection procedures are as follow.

Check for

- (1) Movements.
- (2) Wear, loss, and/or clogging of/at the teeth of the cam and screw.
- (3) Deformation of main body.
- (4) Deformation of shackle.
- (5) The status of bolts, pins, links and springs.
- (6) Deep scratches in general.
- (7) Other checking items based on the Standards.

# Lifting angle and rated load of wire rope

The maximum rated capacity of wire ropes also differs according to the lifting angle.  
Therefore, after paying attention to the lifting angle, always use wire ropes with the appropriate diameter.

## Correlation table between the lifting angle and the applicable load for wire rope (for 2-point lifting)

■ JIS G 3525 6×24 A type

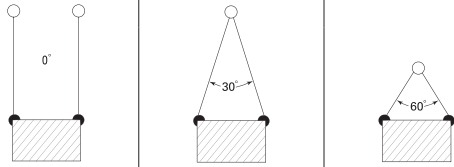
D wire rope diameter (mm)	W rated load (for 1 single rope) [ Safety factor S=6 ] (ton)			
		(Change in % of the lifting capacity rate according to the lifting angle)		
		100%	96%	86%
Maximum allowable load (rated load) for 2 wire ropes (ton)				
6	0.30	0.60	0.57	0.51
8	0.53	1.07	1.03	0.92
9	0.67	1.35	1.30	1.16
10	0.83	1.67	1.61	1.44
12	1.20	2.41	2.32	2.08
14	1.64	3.28	3.15	2.83
16	2.14	4.28	4.12	3.69
18	2.72	5.44	5.23	4.69
20	3.35	6.70	6.44	5.77
22	4.06	8.12	7.81	7.00
24	4.82	9.65	9.28	8.32
26	5.66	11.3	10.8	9.76
28	6.58	13.1	12.6	11.3
30	7.55	15.1	14.5	13.0
32	8.58	17.1	16.5	14.8
36	10.8	21.7	20.8	18.7
40	13.4	26.8	25.8	23.1

## Calculation formula of a wire rope diameter and rated load (for 1 single rope)

\* Refer to the calculated values as rough indications.

①  $D = \sqrt{W \times C}$

②  $W = \frac{D^2}{C}$

D= wire rope dia. (mm)  
W= rated load (ton)  
C= 120 (constant)  
(with Safety factor S = 6)

★ When looking for the required wire rope diameter to lift a 3 ton load

①  $D = \sqrt{W \times C}$

$D = \sqrt{3 \times 120} = \sqrt{360} = 19 \rightarrow$

**20mm**

★ When looking for the maximum capacity (rated load) of a wire rope with 12mm diameter

②  $W = \frac{D^2}{C}$

$W = \frac{12^2}{120} = \frac{144}{120} = 1.2 \rightarrow$

**1.2ton**



# Screw Cam Clamp

(J Type)

## SJC

Operation Manual and Inspection Standards



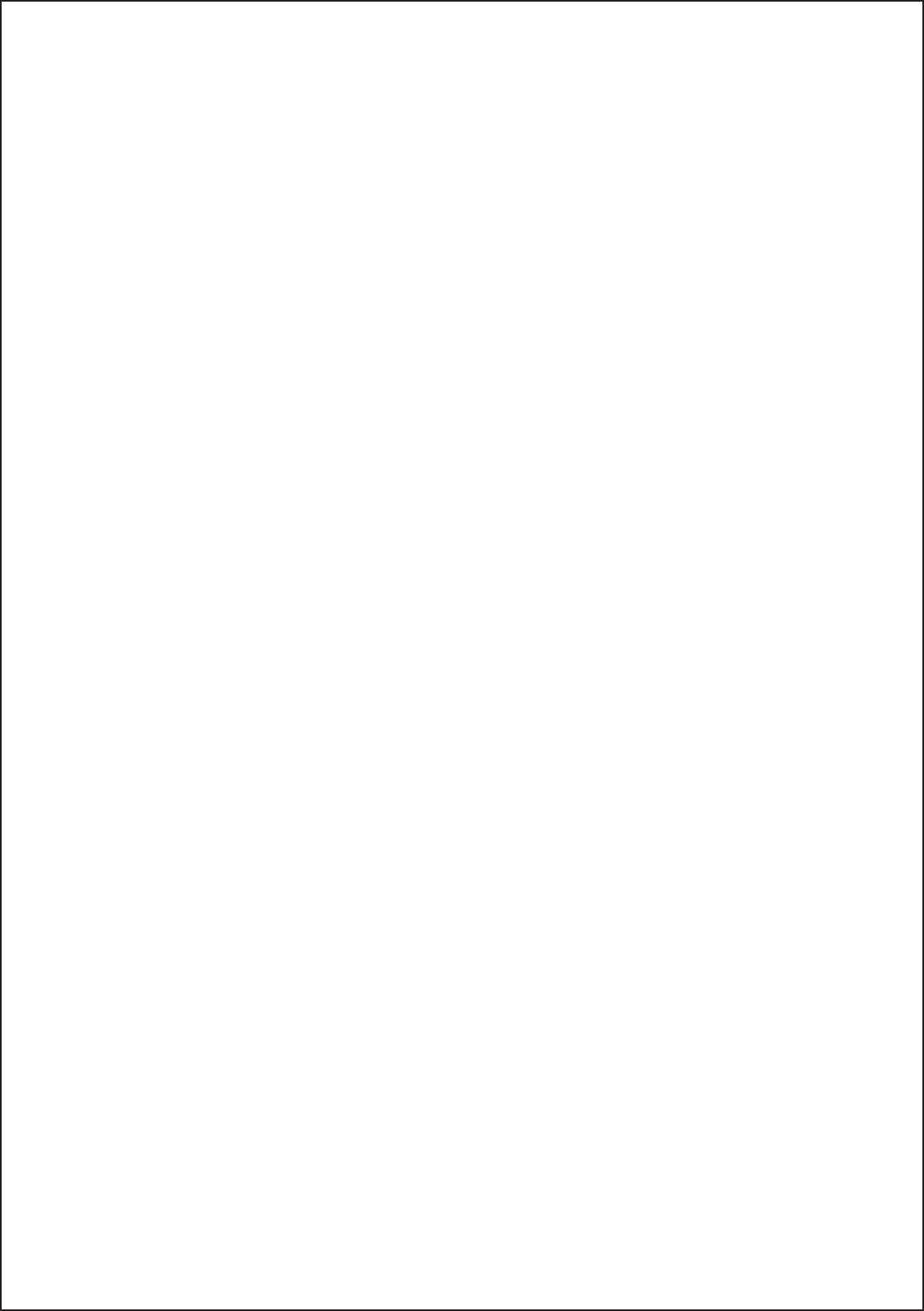

# Screw Cam Clamp

(J Type)

## SJC

### ■ Uses

Clamps suitable for lifting, suspending, lateral pulling, and turning over steel plates and shapes in various industries including civil engineering, construction, iron and steel, shipbuilding, and drum manufacturing industries.

It is also ideal for hanging chain blocks, hoists, etc., and pulling of steel materials, etc., as a jig.

### ■ Features

1. Clamp securely with screws and circular cam.
2. In proportion to the lifting load, the circular cam tilts and the contact surface becomes larger and clamps more firmly.
3. The circular cam is designed whereby the spring forces always make it return to the normal position.
4. The main body is a mold forged product of special alloy steel processed with optimal heat treatment, thus strong and durable.

### ■ Specifications

Item No.	Rated Capacity (ton)	Clamp Range (mm)	Net Weight (kg)
SJC 0.5	0.5	0~25	1.6
SJC 1	1	0~40	2.6
SJC 2	2	0~40	3.8
SJC 3	3	0~40	4.8

## REPLACEMENT PARTS AND FITTINGS

Part No.	Part Name			Set Q'ty
	Set	Detail	Item No.	
1	Screw Assembly	Screw	SJCR	1
2		Handle		1
3	Cam Assembly	Circular cam	SJT	1
4		Stopper pin		2
5		Cam holder		1
6		Retaining ring		1
7		Spring		1
8		Steel ball		1

Attention :

- 1) When ordering, specify the capacity (TON) of ITEM No.  
(For instance, the cam for SJC3 is SJT3.)
- 2) Periodic lubrication is required at cam holder and screw.

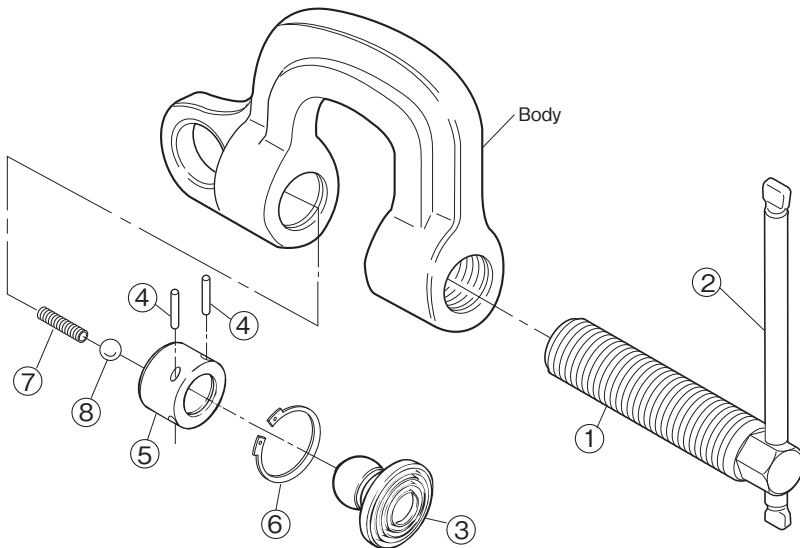



## ■ How to use

### 1. OPERATION METHOD

- 1) The screw will tighten when turned clockwise, and will loosen when turned counterclockwise.
- 2) The cam will retreat about 3mm after coming into contact with the steel plate when tightening the screw. Continue to tighten the screw until the cam is firmly in contact with the steel plate. The tightening torque of the screw must exceed  $25\text{N}\cdot\text{m}$  (about  $250\text{Kgf}\cdot\text{cm}$ ).
- 3) When setting the clamp, insert the object to be lifted completely into the jaw opening until it comes into contact with the deepest section. Tighten the screw firmly till all sections of the inner cam tooth ring come into square contact with the object to be lifted.

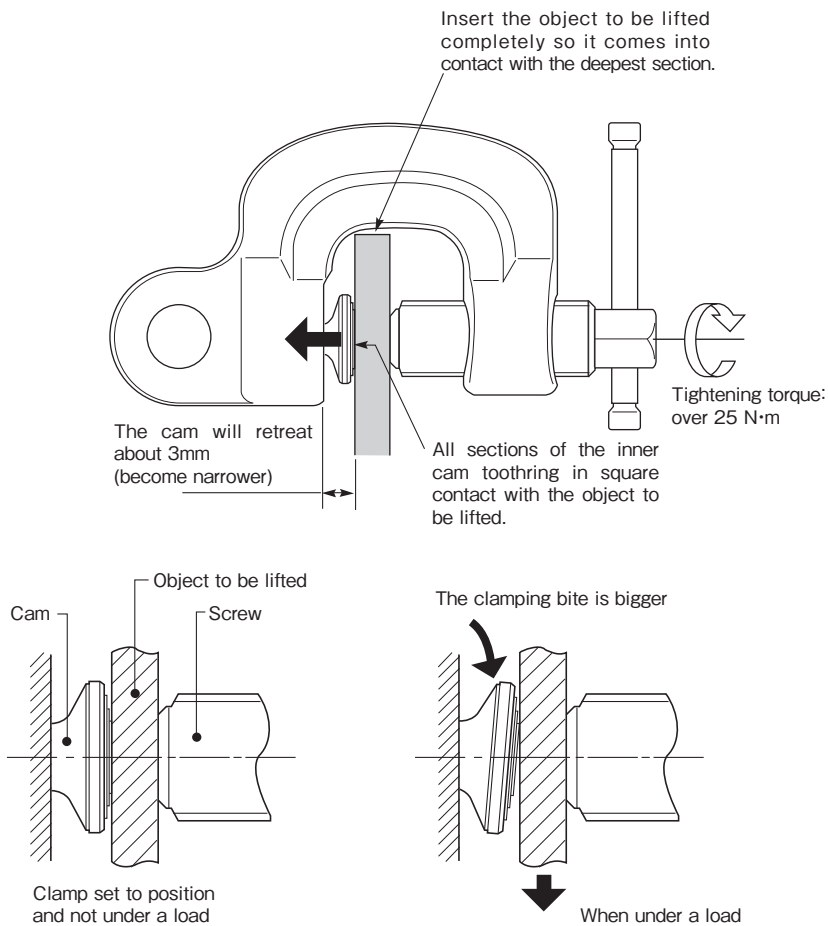

## 2. METHOD OF USE

### ① For lifting

(1) When lifting at 2 points, keep the lifting angle within  $60^\circ$ .

(Always lift work pieces at 2 or more points for safety).

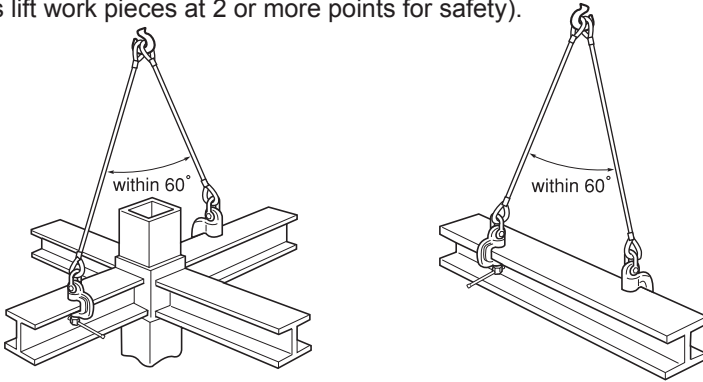

(2) Always lift at 3 points with complicated shaped objects, and balance the work pieces at the proper clamping position and with the proper length of wire rope.

Keep the lifting angle within  $60^\circ$  between ropes.

(When lifting steel plates horizontally, always lift at 4 points.)

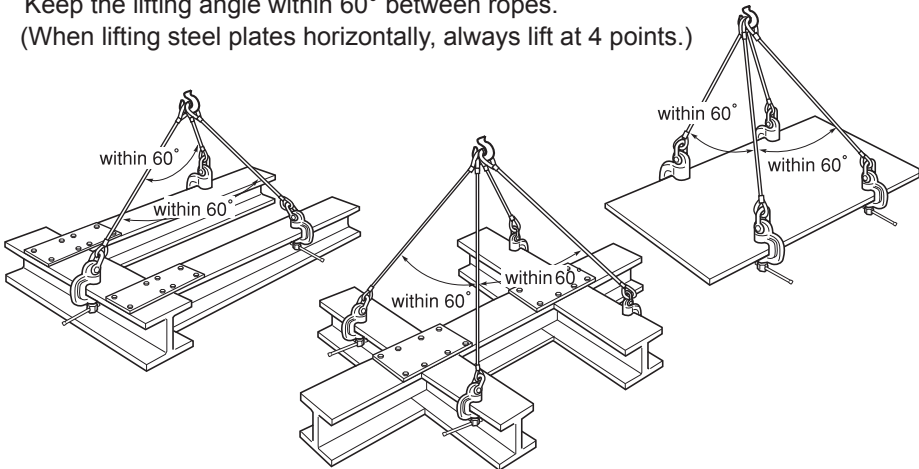

(3) The clamps can also be used shaped steels temporarily for turning over.

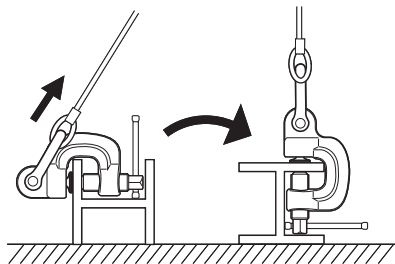

## ② For hanging

(1) When hanging hoist and chain blocks, keep the angle of hanging directions within  $30^\circ$ .

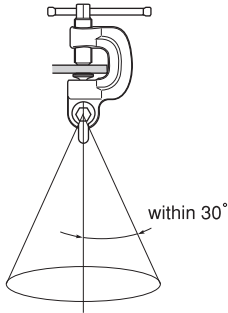

(2) When hanging hoist and chain blocks, always connect U-shackles to lifting ring.

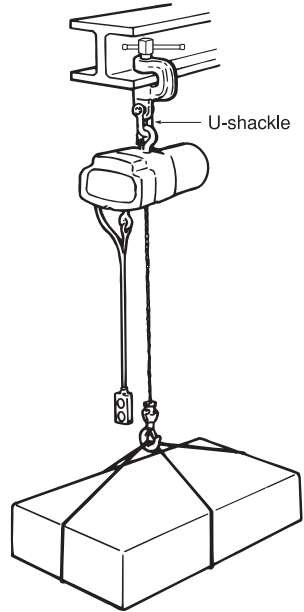

(3) When hanging from two different pillars.

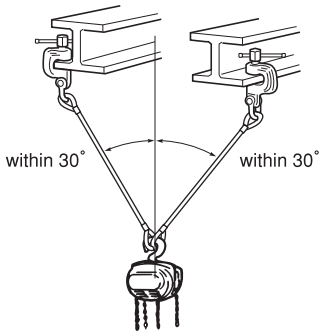

※When the clamps are used continuously for hanging hoist and chain block over a long period of time, check the clamping force regularity at short intervals.

③ The clamps are used for positioning steel structures for welding or pulling.  
(Never be overloaded)

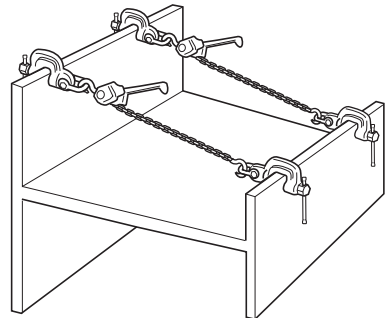
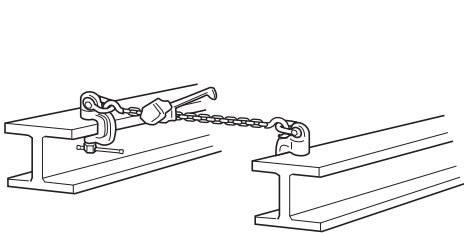

**WARNINGS) The clamps can not be used on the following shaped structures;**

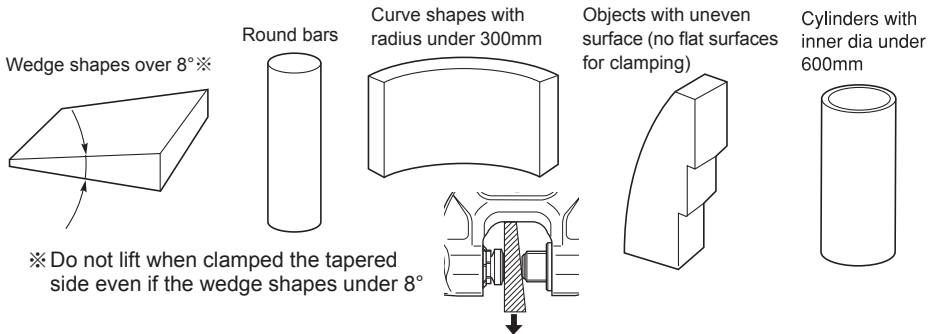

**REPLACEMENT PROCEDURE FOR CAM AND SCREW**

**① DISASSEMBLING**

- (1) Turn Screw counterclockwise and remove it from the Body.
- (2) As show in the drawing on the right, tilt the circular cam and remove the retaining ring with snap ring pliers. Next, remove cam holder, steel ball and spring from the body. (Fig.1)
- (3) Remove two stopper pins from the cam holder and detach the circular cam and the retaining ring.(Fig.2)

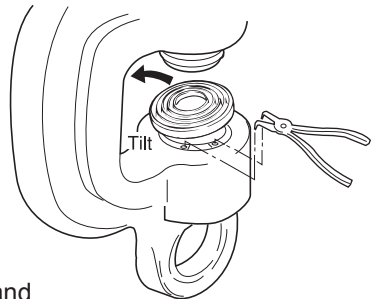

**(Fig.1)**

**② ASSEMBLING**

- ① Connect the retaining ring temporarily on the stem of the circular cam.
- ② Insert the circular cam into the cam holder from the sphere-shaped section and fix them with two stopper pins.
- ③ Insert the spring and next steel ball into the bottom hole of the cam holder.
- ④ Insert the cam holder assembly of ② into the hole of the body and then make sure to set the steel ball of ③ to the bottom hole of the cam holder.
- ⑤ Fix the retaining ring of ① to the groove of the body with snap ring pliers.
- ⑥ Replace and tighten the screw.

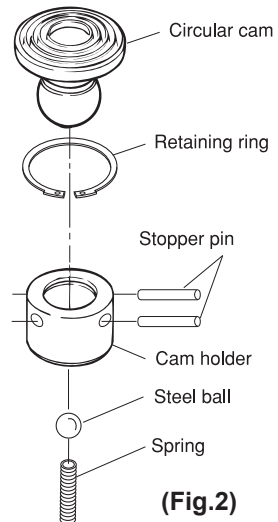

**(Fig.2)**

## ■ CAUTION:

- ◆ Use within the rated capacity.
- ◆ Use within the clamp range.
- ◆ Do not use for any objects other than steel materials.
- ◆ Do not use for hard (30 HRC or higher) load.
- ◆ Lifting is not allowed for a load tapering down in upward direction.
- ◆ Do not apply shock to the load or lifting clamp.
- ◆ Do not lift more than one plate.
- ◆ Before using the product, be sure to check for clogging and wear of the teeth of the cam, screw and any other parts.
- ◆ Do not alter. Heating, modifying, etc. will significantly reduce the quality (strength).

## ■ OTHER:

- ◆ Inquiries for Repair Parts and Repair.  
If repair parts or repairs are required, stop using this clamp and contact your distributor.

## ■ DAILY INSPECTION:

Conduct daily checks and maintenance to prevent the loss of safety and efficiency.

1. Check that there are no cracks at the body, cam, or wire rope holes.
2. Check if the movement and lubrication condition of each part are good.
3. **Check for wear, loss, or clogging of the teeth of the cam and screw.**
4. Refer to other inspection standards.

# INSPECTION STANDARDS FOR SJC

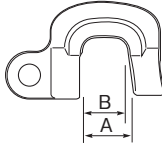
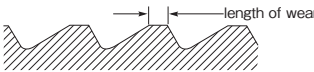
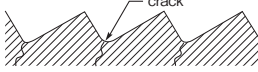
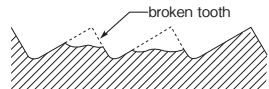
Item	Inspection method	Limit of use	Remedy															
<p><b>Body</b></p>	<p>Visually check or use color dyes to find cracks.</p> <p>Check wear or deformation of shackle and screw hole.</p> <p>Measure the jaw opening.</p>	<p>When found visually.</p> <p>When the diameter of any one part of circumference of any hole exceeds the respective size in the table below.</p>  <table border="1" data-bbox="492 470 851 566"> <thead> <tr> <th>Rated capacity (ton)</th> <th>0.5</th> <th>1</th> <th>2</th> <th>3</th> </tr> </thead> <tbody> <tr> <td>D1 (mm)</td> <td>22.5</td> <td>26.5</td> <td>36.5</td> <td>45.5</td> </tr> <tr> <td>D2 (mm)</td> <td>27.5</td> <td>27.5</td> <td>27.5</td> <td>32.3</td> </tr> </tbody> </table> <p>When the difference of "A" and "B" exceeds 5%. (5mm or more against 100mm in depth.)</p>  <p>When the displacement of the center of Screw and Cam exceeds 2mm.</p>	Rated capacity (ton)	0.5	1	2	3	D1 (mm)	22.5	26.5	36.5	45.5	D2 (mm)	27.5	27.5	27.5	32.3	<p>Discard</p>
	Rated capacity (ton)	0.5	1	2	3													
D1 (mm)	22.5	26.5	36.5	45.5														
D2 (mm)	27.5	27.5	27.5	32.3														
<p><b>Screw</b></p>	<p>Visually check or use color dyes to find cracks.</p> <p>Visually check for bending.</p> <p>Measure the screw teeth for wear.</p> <p>Visually check or measure the degree of wear.</p> <p>Visually check or use color dyes to find cracks at the teeth bottom.</p> <p>Visually check for broken teeth.</p>	<p>When found visually.</p> <p>When the displacement of the screw center exceeds 2mm.</p> <p>When the movement is not smooth.</p> <p>When thread part on circumference exceeds the respective size in the table below.</p> <table border="1" data-bbox="492 1045 851 1117"> <thead> <tr> <th>Rated capacity (ton)</th> <th>0.5</th> <th>1</th> <th>2</th> <th>3</th> </tr> </thead> <tbody> <tr> <td>Diameter (mm)</td> <td>29.3</td> <td>29.3</td> <td>29.3</td> <td>34.2</td> </tr> </tbody> </table> <p>When the degree of wear exceeds 0.5mm..</p>  <p>When found visually.</p>  <p>When any broken tooth is found.</p> 	Rated capacity (ton)	0.5	1	2	3	Diameter (mm)	29.3	29.3	29.3	34.2	<p>Replace</p>					
Rated capacity (ton)	0.5	1	2	3														
Diameter (mm)	29.3	29.3	29.3	34.2														

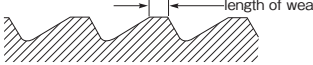
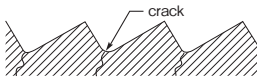
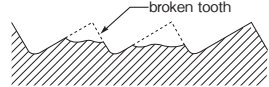
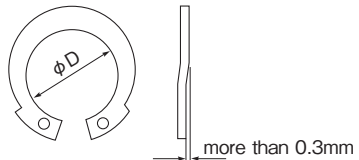
Item	Inspection method	Limit of use	Remedy										
<b>Spring</b>	<p>Visually check if Cam returns automatically to an original position when moved by hands.</p> <p>Visually check clearance of spring coils.</p>	<p>When Cam does not return to its original position due to the loss of adequate repulsive power from deformation.</p> <p>When the spring becomes 5% shorter than its original length or when the clearance between the coils becomes small.</p>	Replace										
<b>Circular Cam</b>	<p>Visually check and measure the degree of wear.</p> <p>Visually check or use color dyes to find cracks at the bottom cam teeth.</p> <p>Visually check for broken cam teeth.</p>	<p>When the degree of wear exceeds 0.5mm..</p>  <p>When found visually.</p>  <p>When any broken tooth is found.</p> 	Replace										
<b>Cam Holder</b>	Measure each section for wear.	When the space among Body, Cam Holder and Cam becomes large, and exceeds 0.5 mm.											
<b>Retaining Ring</b>	Measure deformation.	<p>When the diameter of any one part of circumference of any hole exceeds the respective size in the table below.</p> <p>When deformation exceeds 0.3mm.</p>  <table border="1" data-bbox="543 1396 901 1460"> <thead> <tr> <th>Rated capacity (ton)</th> <th>0.5</th> <th>1</th> <th>2</th> <th>3</th> </tr> </thead> <tbody> <tr> <td>D (mm)</td> <td>22.0</td> <td>22.0</td> <td>29.7</td> <td>30.5</td> </tr> </tbody> </table>	Rated capacity (ton)	0.5	1	2	3	D (mm)	22.0	22.0	29.7	30.5	Replace
Rated capacity (ton)	0.5	1	2	3									
D (mm)	22.0	22.0	29.7	30.5									

Item	Inspection method	Limit of use	Remedy										
<b>Stopper Pin</b>	Measure each section for wear.  Visually check or measure to find deformation.	When the space with the hole of Cam Holder exceeds 2mm, resulting rattling.  When deformation exceeds 0.2mm.  When the movement of Cam is not smooth.	Replace										
<b>Steel Ball</b>	Measure wear or deformation.	Replace when ball diameter of ball exceeds the size in the table below.  <table border="1" data-bbox="501 523 863 596"> <tr> <td data-bbox="501 523 628 564">Rated capacity (ton)</td> <td data-bbox="630 523 687 564">0.5</td> <td data-bbox="689 523 747 564">1</td> <td data-bbox="749 523 806 564">2</td> <td data-bbox="808 523 863 564">3</td> </tr> <tr> <td data-bbox="501 568 628 596">Diameter (mm)</td> <td data-bbox="630 568 687 596">4.8</td> <td data-bbox="689 568 747 596">4.8</td> <td data-bbox="749 568 806 596">5.8</td> <td data-bbox="808 568 863 596">5.8</td> </tr> </table> When the movement of Cam is not smooth.	Rated capacity (ton)	0.5	1	2	3	Diameter (mm)	4.8	4.8	5.8	5.8	Replace
Rated capacity (ton)	0.5	1	2	3									
Diameter (mm)	4.8	4.8	5.8	5.8									



